

# المنهاج الوطني التفاعلي

الطبعة المطورة

كتاب الأنشطة باللغة العربية

الجزء الأول



رياض الأطفال

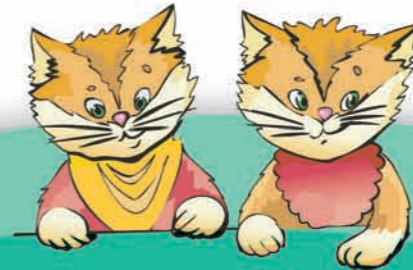
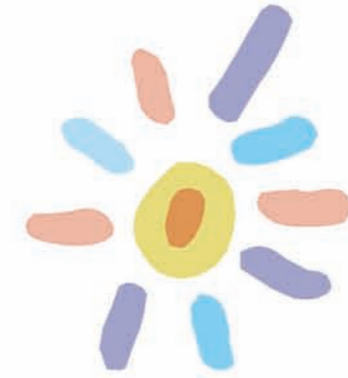

اسمي: .....

ISBN : 978-9957-84-008-2



9 789957 840082

# المنهاج الوطني التفاعلي

الطبعة المطورة

## كتاب الأنشطة باللغة العربية

رياض الأطفال

الجزء الأول

الفريق الوطني لتأليف المواد التعليمية للمنهاج الوطني التفاعلي / الطبعة المطورة

د. موفق الزعبي (رئيساً)

منال البكور

د. آمال البعجاوي

د. أيوب الروسان

ختام الخزاعلة

عبير الشبول

د. هيثم أبو زيد

نداء خضر

د. عالية عربيات

سناء حمادنة

د. أميمة عمور (مقرراً)

الناشر

وزارة التربية والتعليم

إدارة المناهج والكتب المدرسية

يسر إدارة المناهج والكتب المدرسية استقبال ملاحظاتكم وآرائكم على هذا الكتاب على العناوين الآتية:

هاتف: ٤١١٧٣٠٤ / ٥ - ٨ فاكس: ٤٦٣٧٥٦٩ ص ب: (١٩٣٠) الرمز البريدي: ١١١١٨

أو على البريد الإلكتروني: EarlyChild.Division@moe.gov.jo



## الْحُقُوقُ جَمِيعُهَا مَحْفُوظَةٌ لِوَزَارَةِ التَّرْبِيَةِ وَالتَّعْلِيمِ عَمَّانُ - الْأُرْدُنُّ / ص.ب (١٩٣٠)

الفريق الوطني للتوجيه والإشراف على تأليف المواد التعليمية للمنهاج الوطني التفاعلي / الطبعة المطوّرة

أ. د. تيسير النهار النعيمي (رئيساً)

د. فوز جرادات  
د. جميل الصمادي  
د. تغريد أبو طالب  
د. محمد الجيوسي  
د. إبراهيم المومني  
د. أميمة عمور (مقرراً)

التحرير العلمي : د. أيوب حمدان الروسان  
التحرير اللغوي : د. عبدالله محمود مانع  
التحرير الفني : محمد أحمد الموسى  
التصميم : فخري موسى الشبول  
الرسوم : فائزة حداد، أحمد صبيح، عاصف نصري  
الإنتاج : د. عبد الرحمن سليمان أبو صعيلىك

دقق الطباعة وراجعها: د. زبيدة حسن أبو شويمة

تم تأليف الطبعة الأولى من المنهاج الوطني التفاعلي بالتعاون مع المجلس الوطني لشؤون الأسرة  
وبدعم من برنامج الخليج العربي لدعم منظمات الأمم المتحدة الإنمائية

### تأليف

د. تغريد فتحي أبو طالب  
شيرين أسعد السعدي  
ليلي نجيب الصايغ

### اللجنة التوجيهية للطبعة الأولى من المنهاج الوطني التفاعلي

د. منذر المصري  
محمد الحيارى  
نايف العموش  
حسين صالح  
ابتسام عمارة  
د. نايفة قطامي  
أمل النحاس  
دارة الطاهر  
لارا حسين

رقم الإيداع لدى دائرة المكتبة الوطنية

(٢٠١٠ / ١٢ / ٤٤٩٦)

ISBN: 978-9957-84-008-2

١٤٢٨ هـ / ٢٠٠٧ م

٢٠٠٨ - ٢٠١٩ م

الطبعة الأولى

أعيدت الطباعة

## قائمة المحتويات

الصفحة

الموضوع

٥ ..... الوَحْدَةُ الْأُولَى : أنا ورؤُوتي

٤٣ ..... الوَحْدَةُ الثَّانِيَّةُ : أُسْرَتِي

٦٥ ..... الوَحْدَةُ الثَّالِثَةُ : حَيَوَانَاتِي

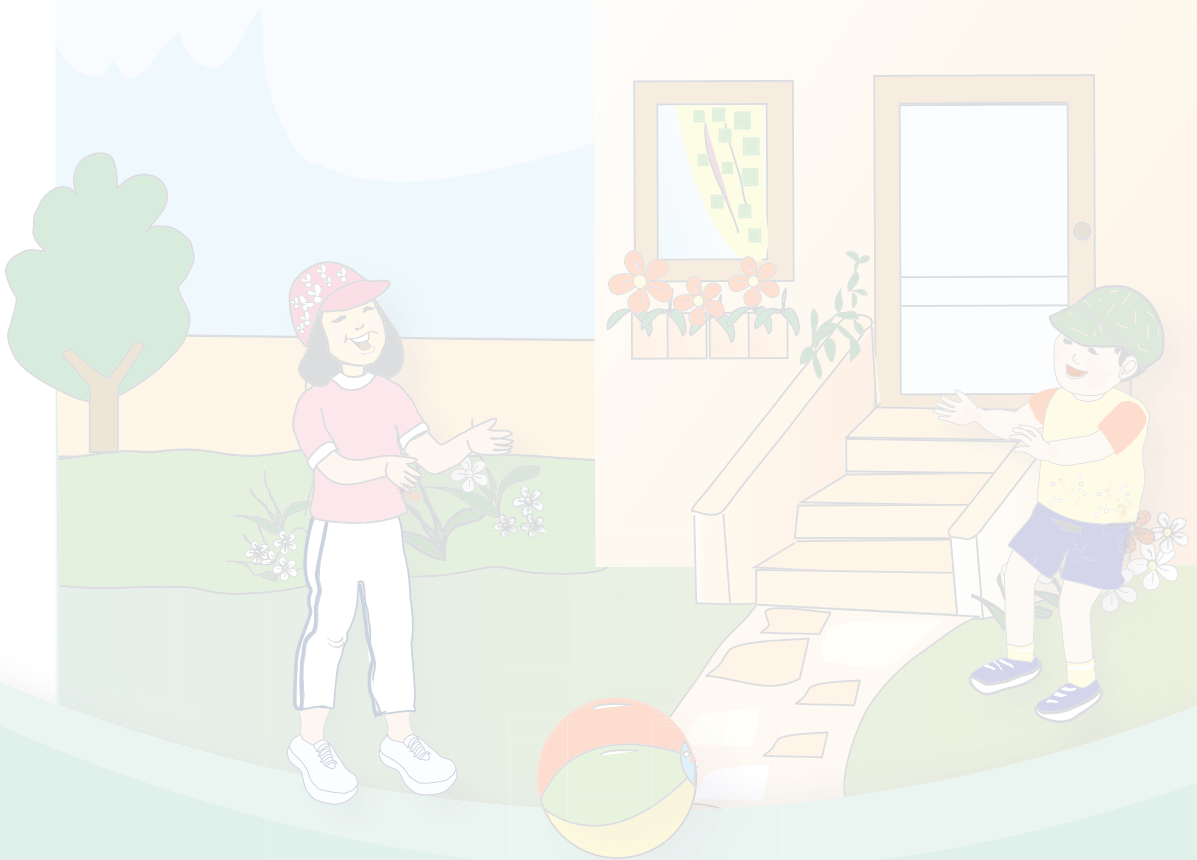





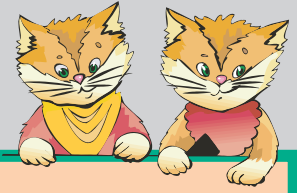

# أنا وروضتي





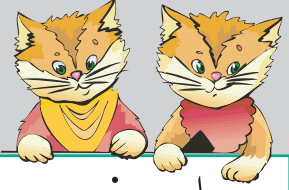

اسمي: ..... التاريخ: .....

أَلصِقْ اسْمِي

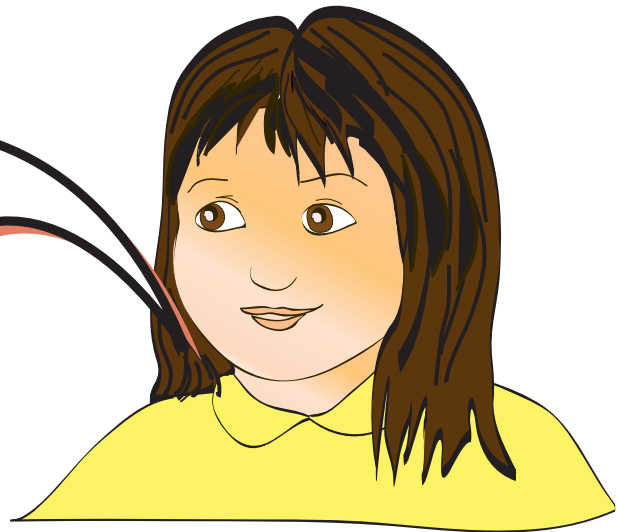
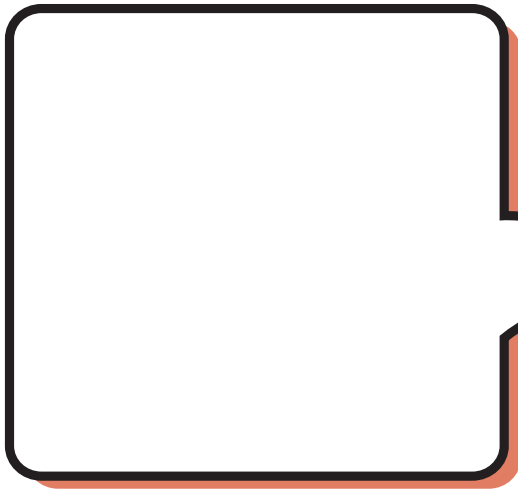

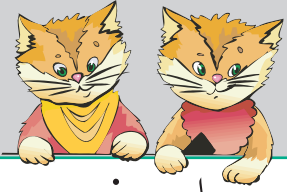

اسمي: ..... التاريخ: .....

أنا

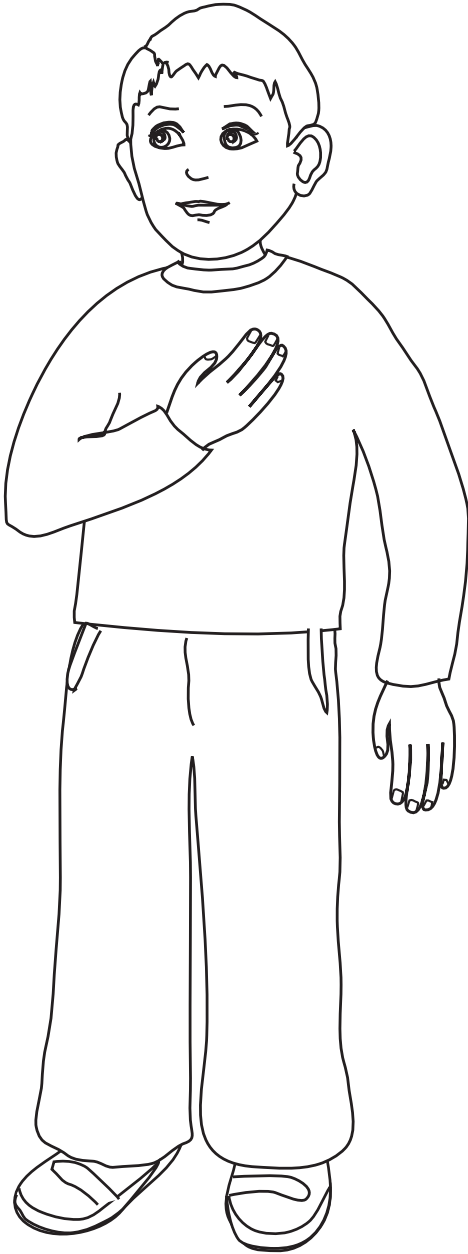



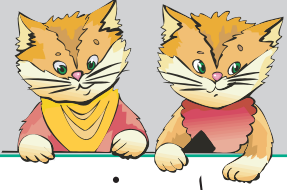

اسمي: ..... التاريخ: .....

أَلُوْنُ حَرْفَ بِ بِ وَأَضَعُ دَائِرَةً حَوْلَهُ فِي الْكَلِمَةِ

بيت



برتقال



كتاب



بساط

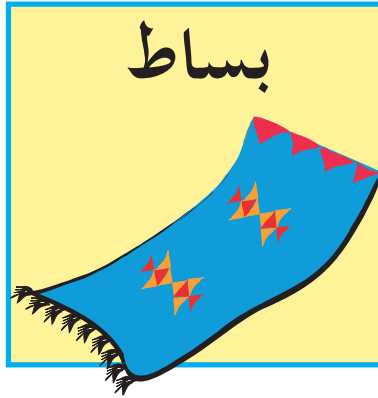

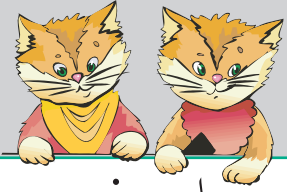

اسمي: ..... التاريخ: .....

## أرسمُ حرفَ بٍ بٍ

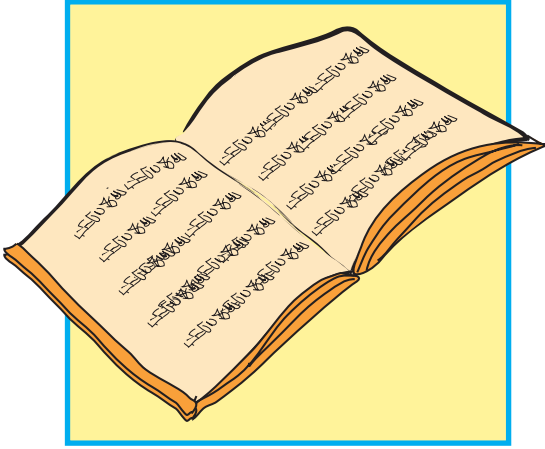

كتاب

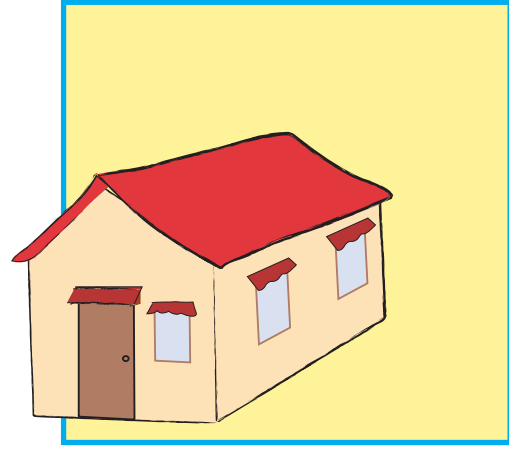

بيت

كتاب

بيت



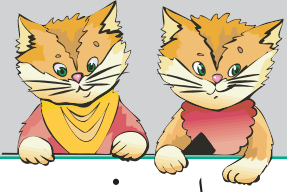

اسمي: ..... التاريخ: .....

أَكْمِلُ الرَّسْمَ وَأُلَوِّنُ الدَّائِرَةَ بِاللَّوْنِ الْأَزْرَقِ

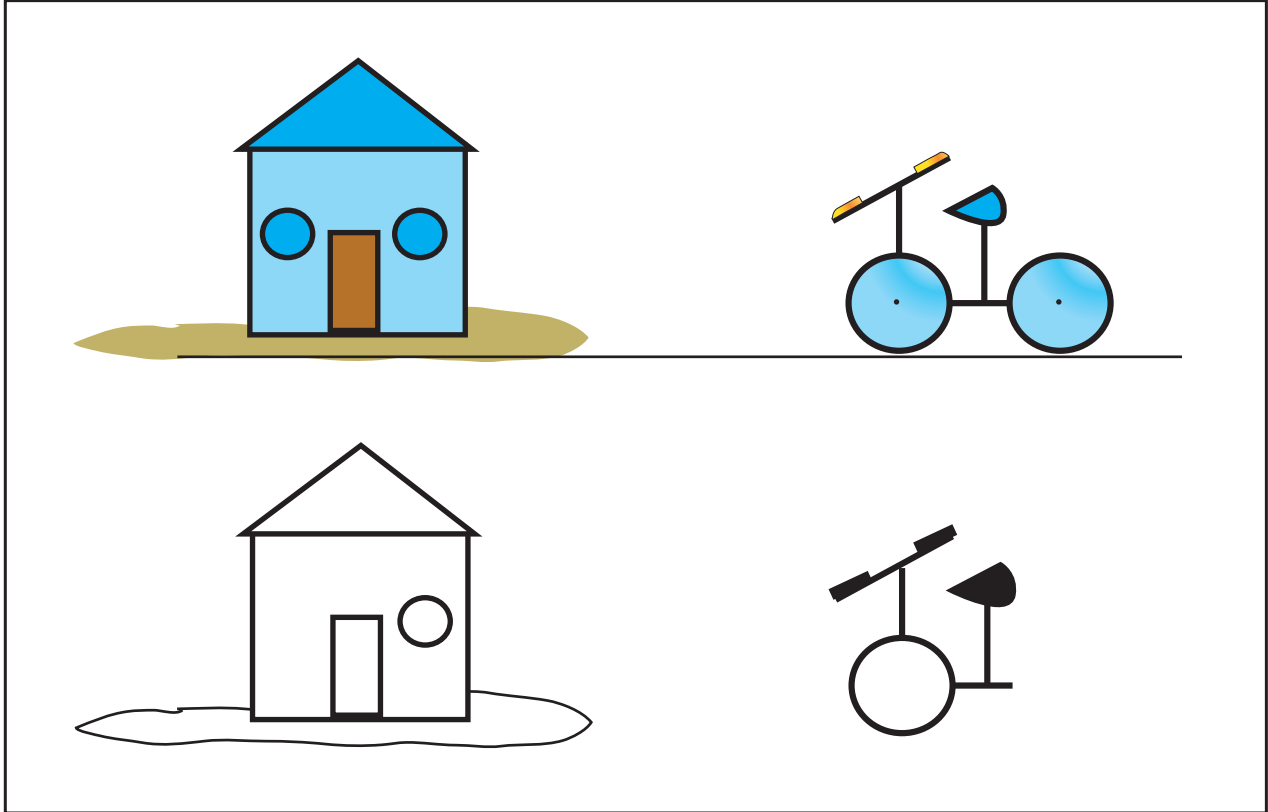

أُلَوِّنُ الدَّائِرَةَ بِاللَّوْنِ الصَّحِيحِ

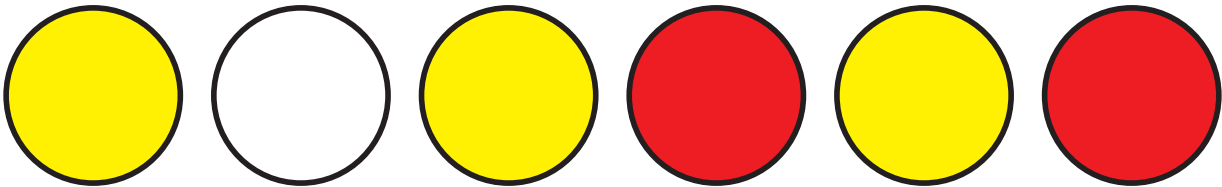

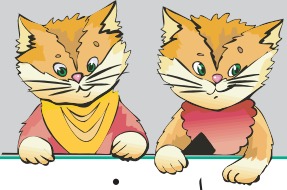

اسمي: ..... التاريخ: .....

## أَلَوْنُ حَرْفِ ِ وَأَضْعُ دَائِرَةَ حَوْلَهُ فِي الْكَلِمَةِ

باب

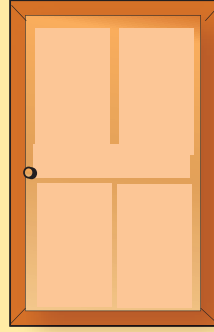

ماس

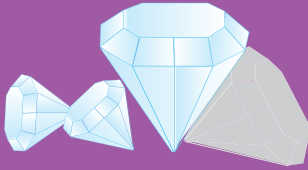

غزال



بساط



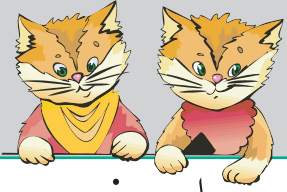

اسمي: ..... التاريخ: .....

## أرسمُ حرفَ ا

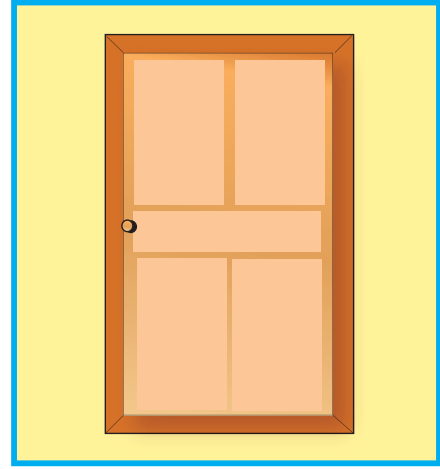
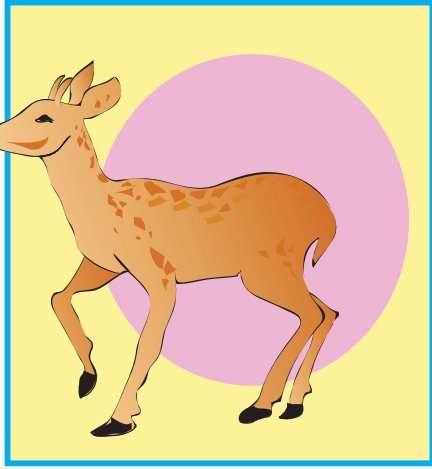

غزال

باب

غزال

باب

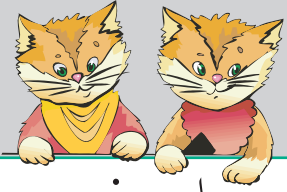

اسمي: ..... التاريخ: .....

## أَلَوْنُ قَوْسِ قُزَحٍ



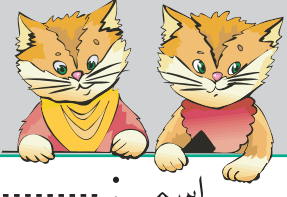

اسمي: ..... التاريخ: .....

## ألون حرف م م وأضع دائرة حولهُ في الكلمة

مثلث

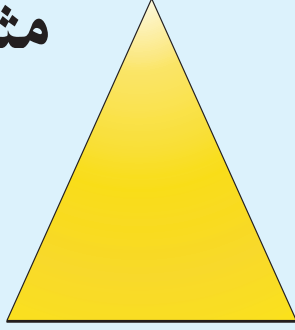

مسجد

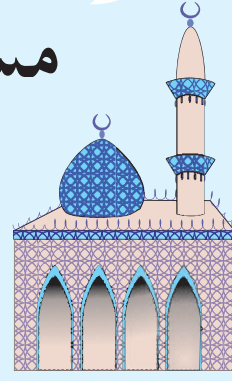

بوم



مفتاح





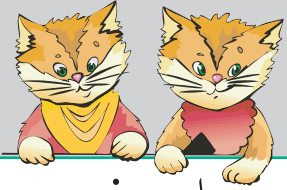

اسمي: ..... التاريخ: .....

## أرسم حرف م م م

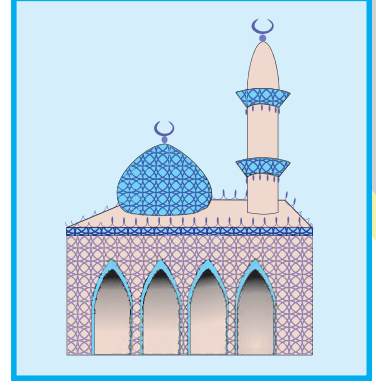
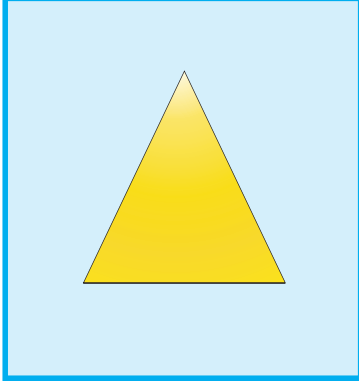

مثلث

بوم

مسجد

مثلث

بوم

مسجد

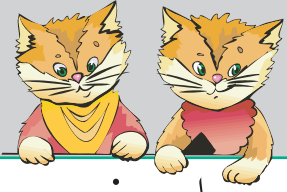

اسمي: ..... التاريخ: .....

## أصل الصورة بالكلمة

يدعو



وردة



ورود



وسادة



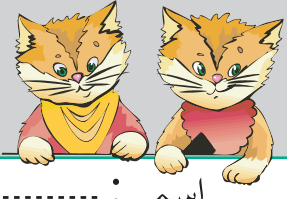

اسمي: ..... التاريخ: .....

## أَلَوْنُ حَرْفِ وِ وَأَضَعُ دَائِرَةً حَوْلَهُ فِي الْكَلِمَةِ

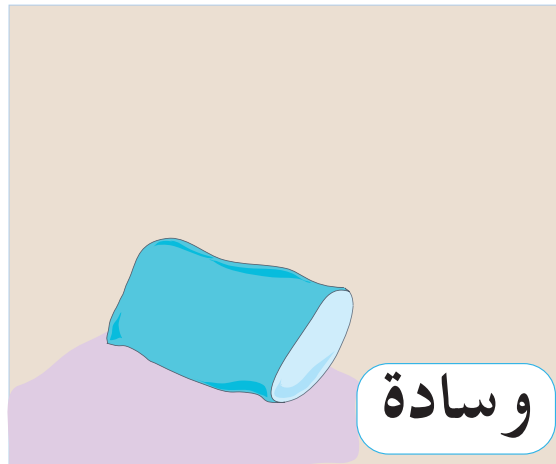
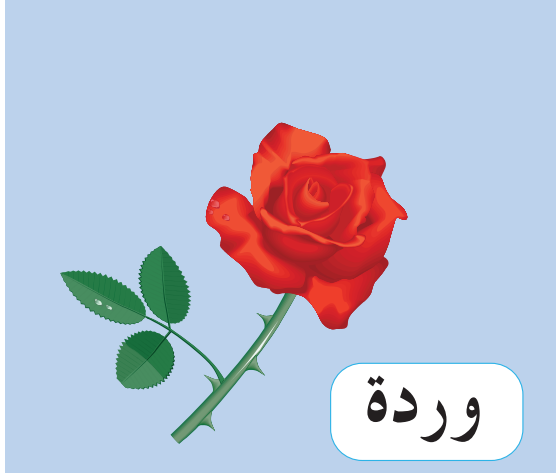

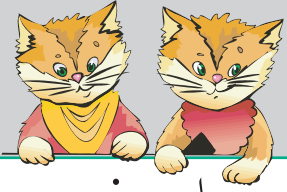

اسمي: ..... التاريخ: .....

## أرسمُ حرفَ و



يدعو

يدعو

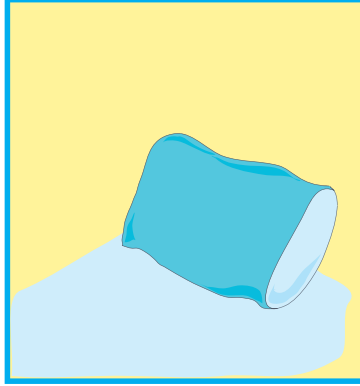

وسادة

وسادة

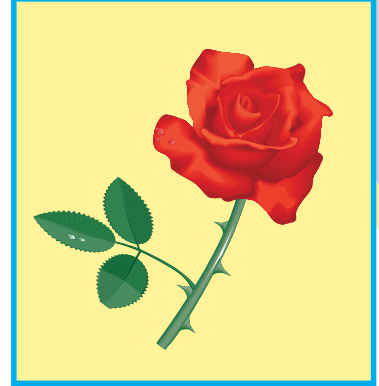

وردة

وردة

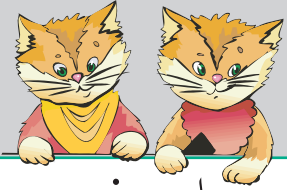

اسمي: ..... التاريخ: .....

أَلَوْنُ رَسْمَةِ الْبَطَّةِ الَّتِي تَقِفُ أَمَامَ أُمِّهَا

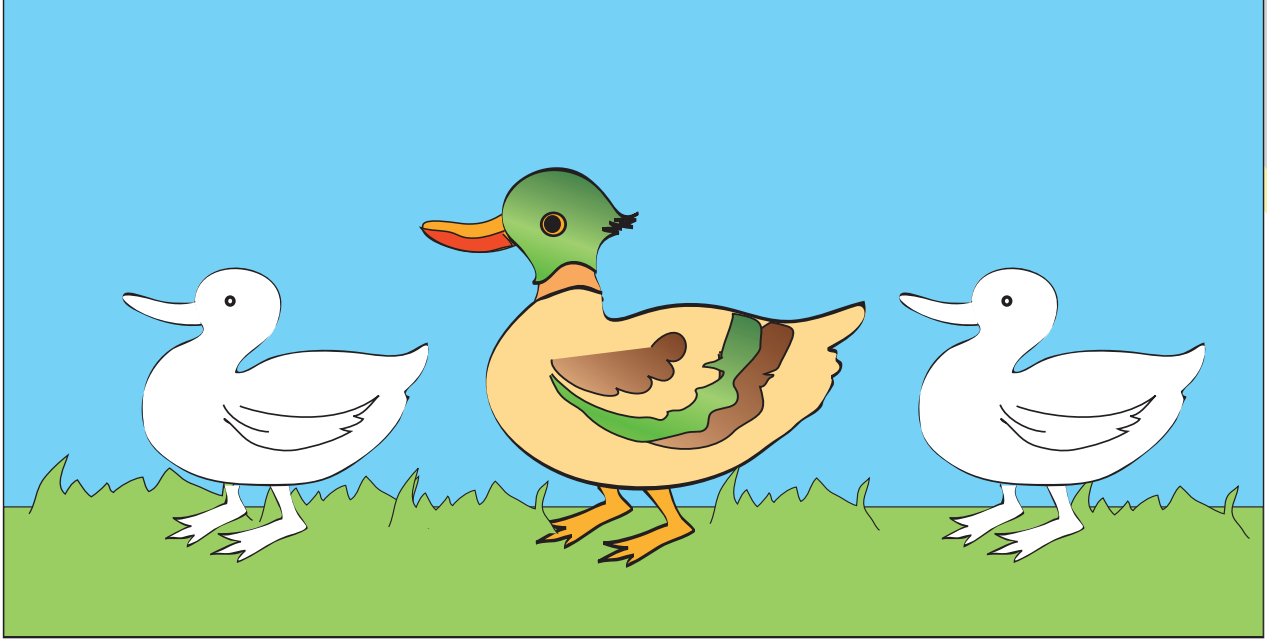

أَلَوْنُ رَسْمَةِ الْبَطَّةِ الَّتِي تَقِفُ خَلْفَ أُمِّهَا

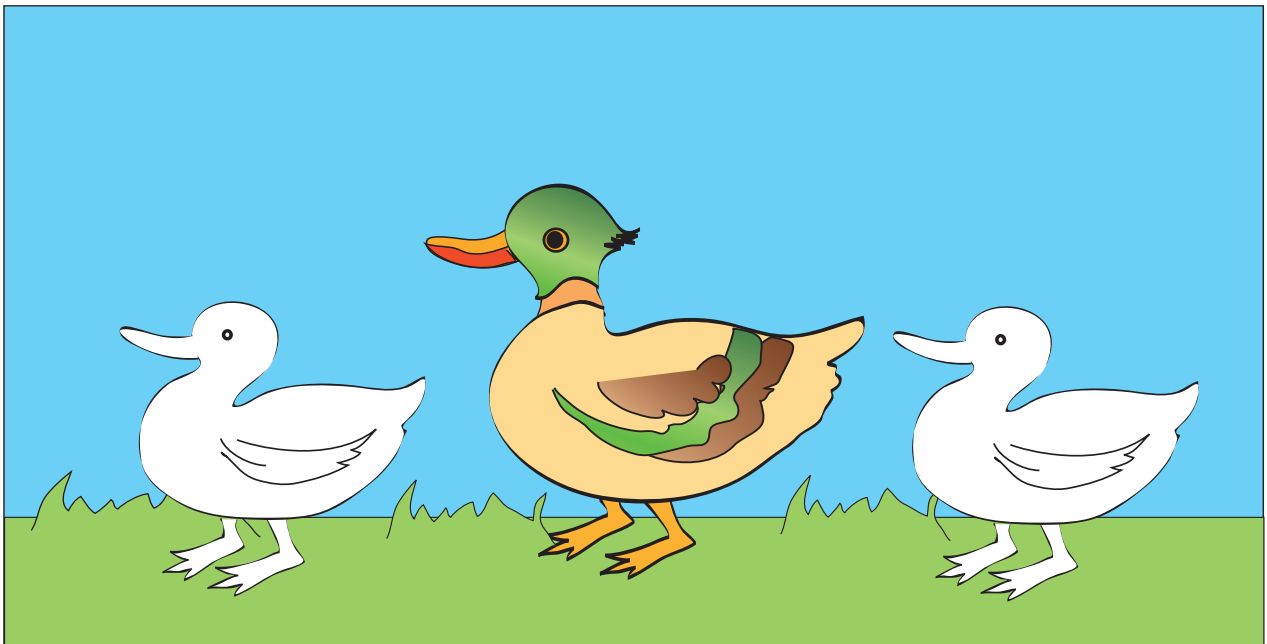

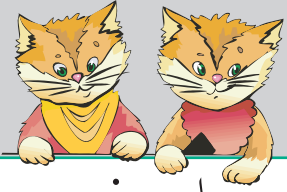

اسمي: ..... التاريخ: .....

## أصل الصورة بالكلمة

عصفور

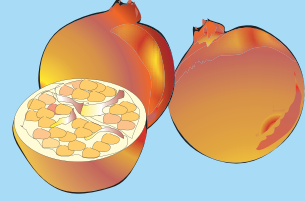

روضة

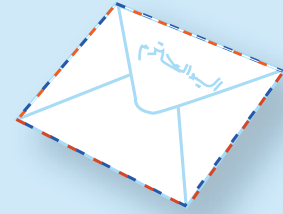

رمان

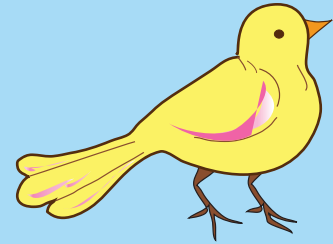

رسالة





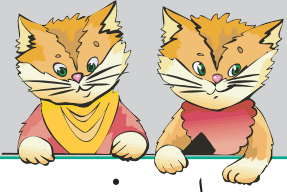

اسمي: ..... التاريخ: .....

## أطابق الصور

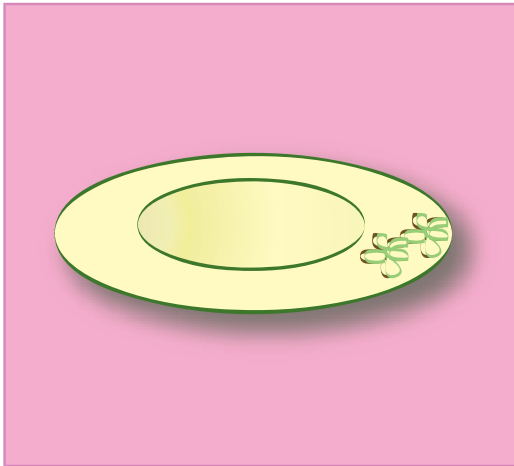
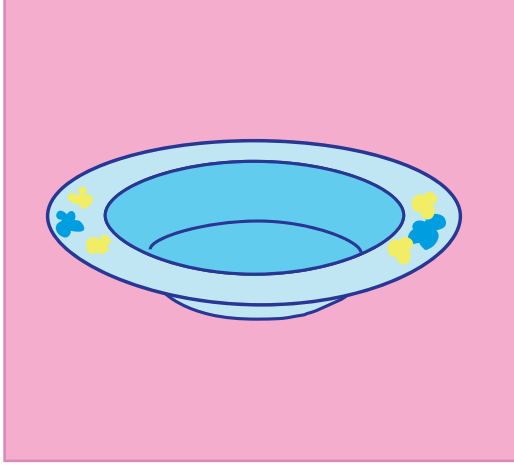

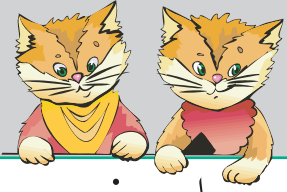

اسمي: ..... التاريخ: .....

## أَلَوْنُ حَرْفِ رٍ وَأَضَعُ دَائِرَةً حَوْلَهُ فِي الْكَلِمَةِ

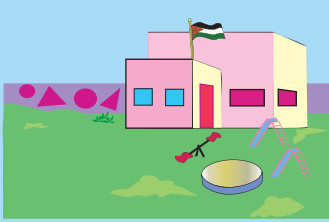

روضتي

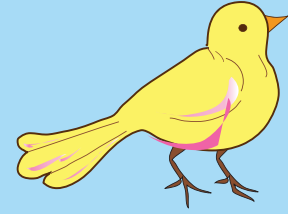

عصفور

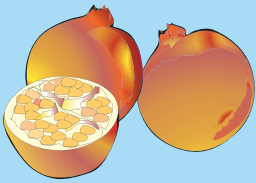

رمان

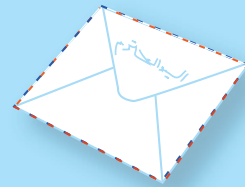

رسالة

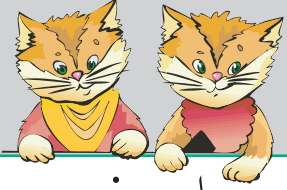

اسمي: ..... التاريخ: .....

## أَلْوَنُ الرَّسْمِ الْأَكْثَرَ عَدَدًا

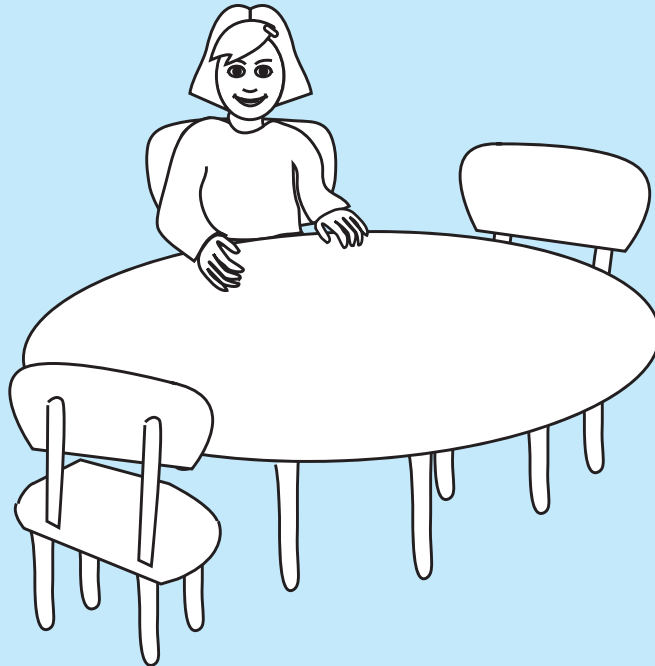
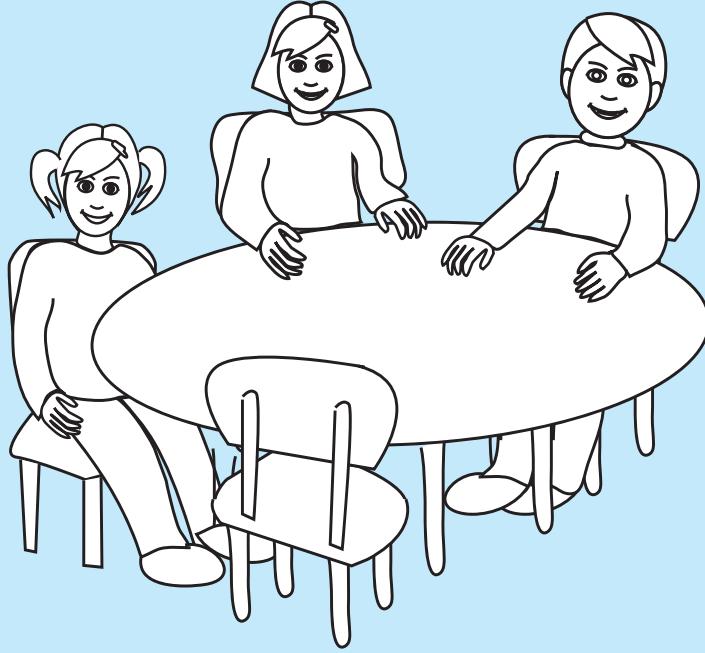

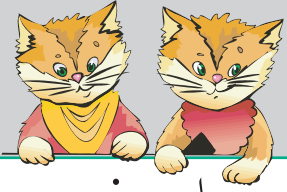

اسمي: ..... التاريخ: .....

## أَبْحَثُ عَنِ الشَّكْلِ وَالْوَنِّهِ

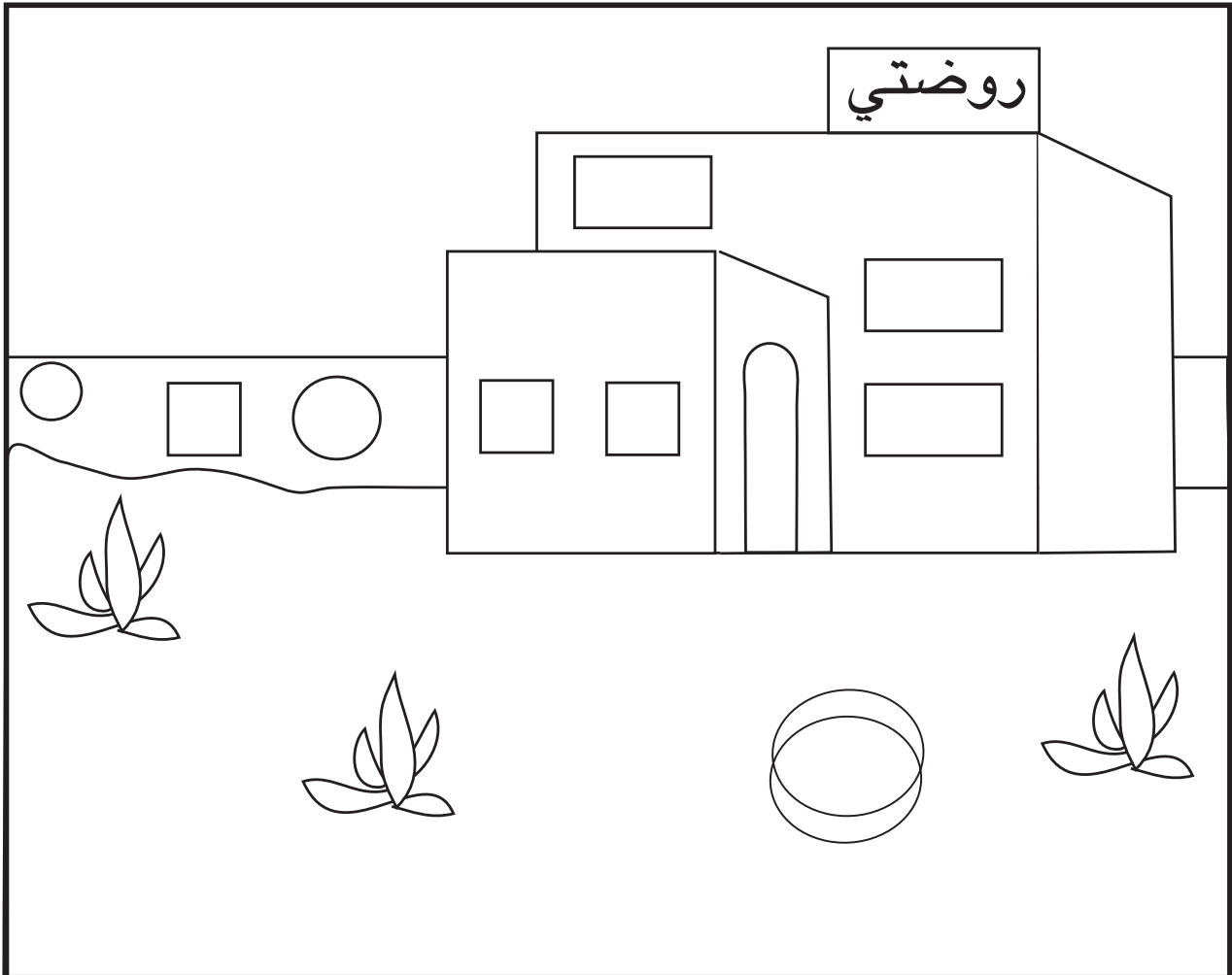
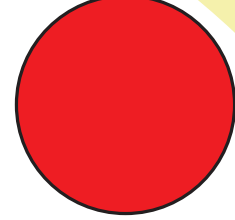
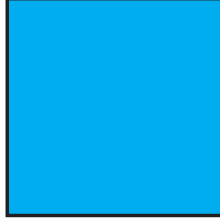
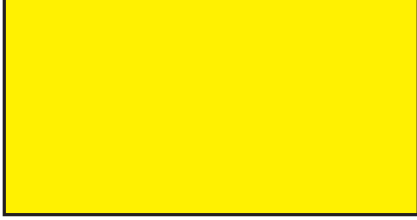

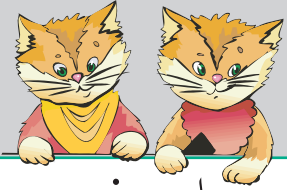

اسمي: ..... التاريخ: .....

## أرسم حرف ر

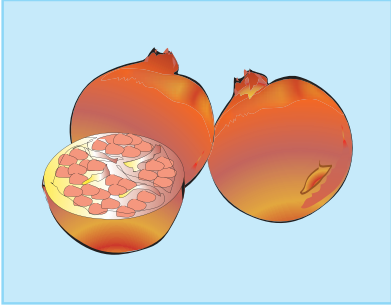

رمان

رمان

رمان .



روضة

روضة

روضة .

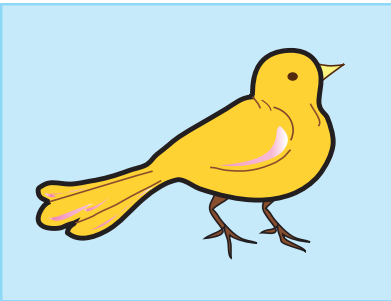

عصفور

عصفور

عصفور .

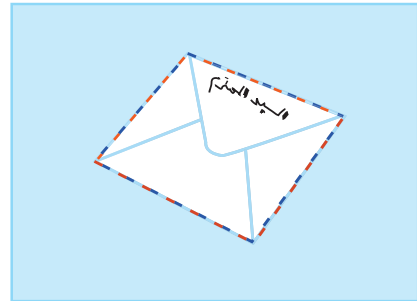

رسالة

رسالة

رسالة .

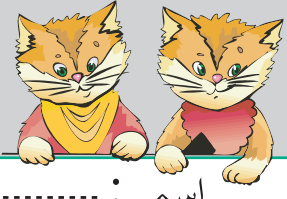

اسمي: ..... التاريخ: .....

## أصل الصورة بالكلمة

يغرد



يد

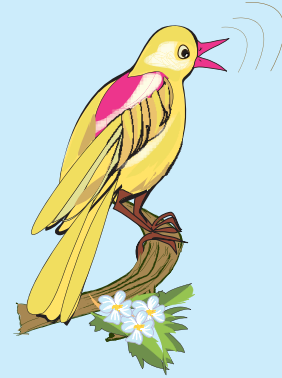

روضتي





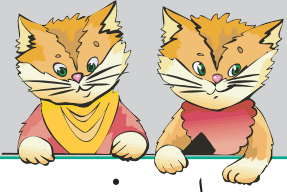

اسمي: ..... التاريخ: .....

## أَلَوْنُ حَرْفِ يَ وَي وَأَضْعُ دَائِرَةً حَوْلَهُ فِي الْكَلِمَةِ

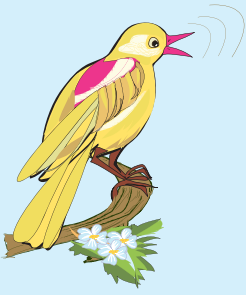

يغرد



روضتي

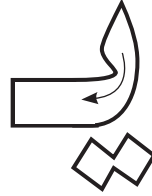
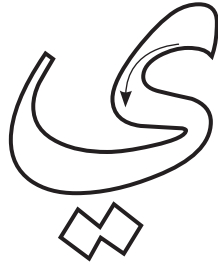

يدعو



يد

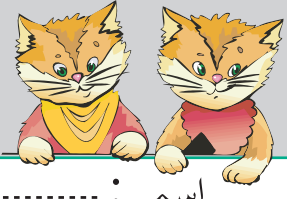

اسمي: ..... التاريخ: .....

## أَلْوَنٌ وَأَصْلٌ

■ أَلْوَنٌ شَيْئًا وَاحِدًا مِنْ كُلِّ مَجْمُوعَةٍ:

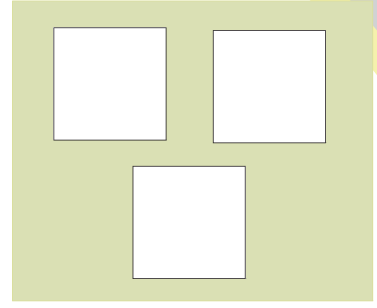
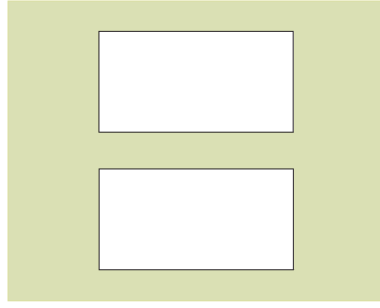
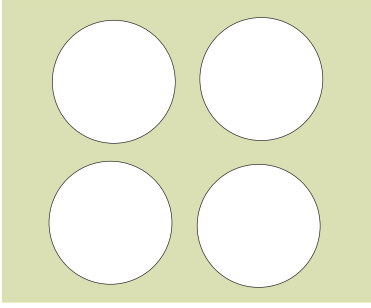

■ أَصِلُ بَيْنَ الصُّورَةِ فِي الْأَعْلَى وَالصُّورَةِ الَّتِي تَحْوِي الْعَدَدَ  
نَفْسَهُ فِي الْأَسْفَلِ:

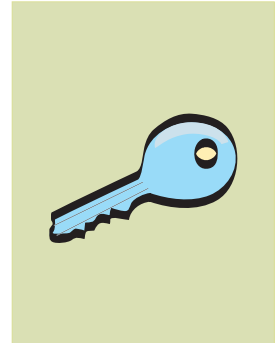
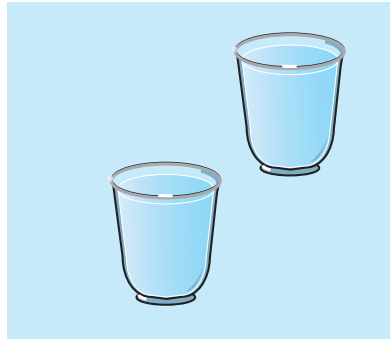

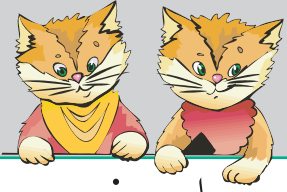

اسمي: ..... التاريخ: .....

## أرسمُ حرفَ يِ يِ

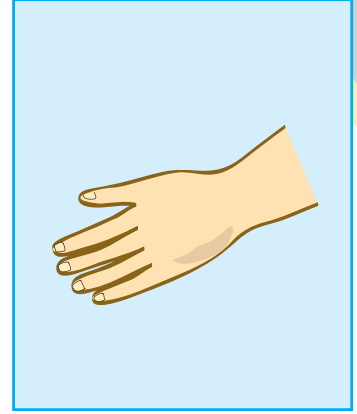
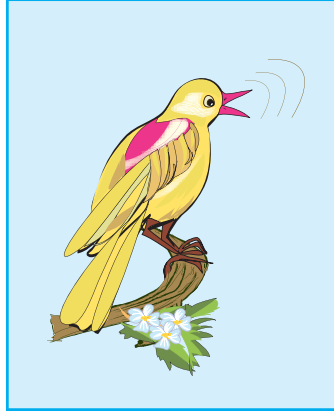

روضتي

يغرد

يد

روضتي

يغرد

يد

روضتي

غرد

د

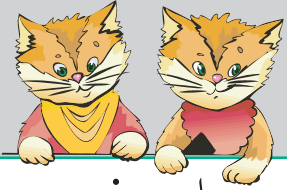

اسمي: ..... التاريخ: .....

## أَلَوْنُ وَأَكْتُبُ الْعَدَدَ ( ١ )

أَلَوْنُ الْعَدَدَ (١):



أُكْمِلُ



أُكْمِلُ



أُكْمِلُ



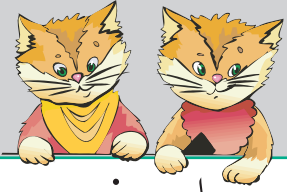

اسمي: ..... التاريخ: .....

## أَحْضِرُ وَأَصِلُ

أَحْضِرُ وَرَدَتَيْنِ فَقَطْ:

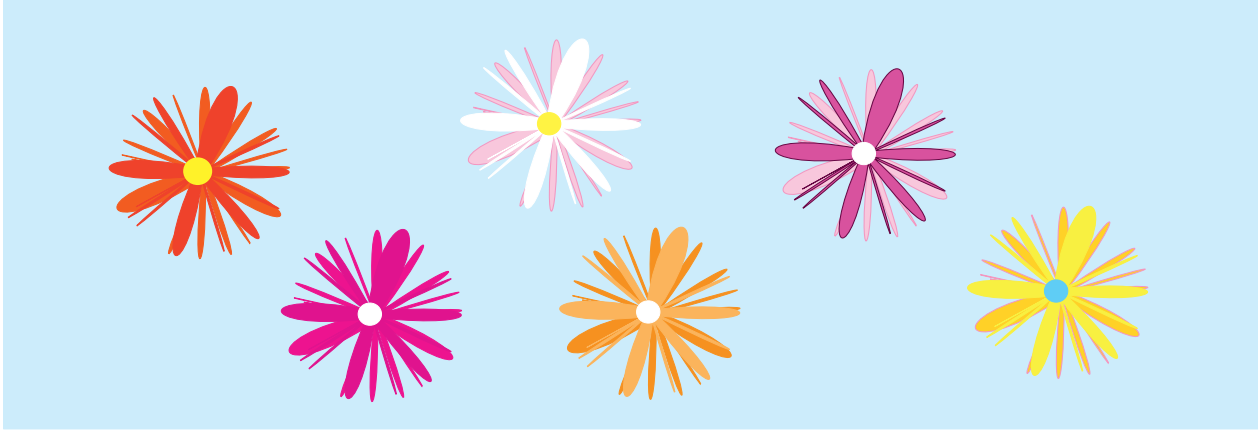

أَصِلُ بِنَحْطٍ بَيْنَ الْمَجْمُوعَاتِ الْمَتَسَاوِيَةِ:

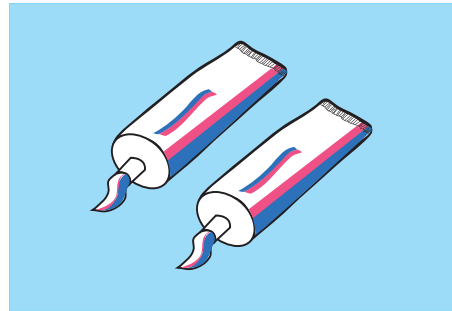
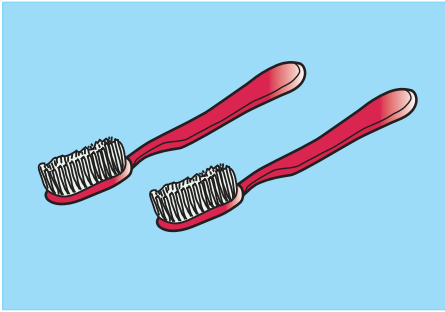

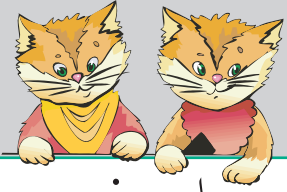

اسمي: ..... التاريخ: .....

## أصل الصورة بالكلمة

تمساح



تمر

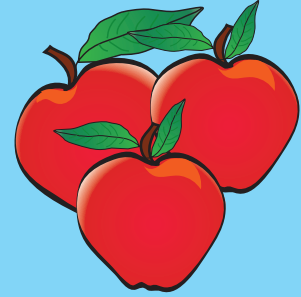

بيت

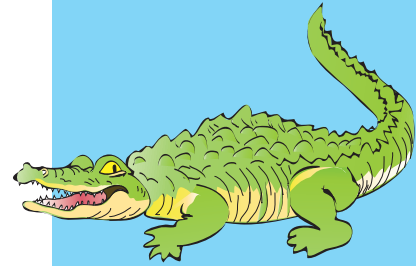

تفاح

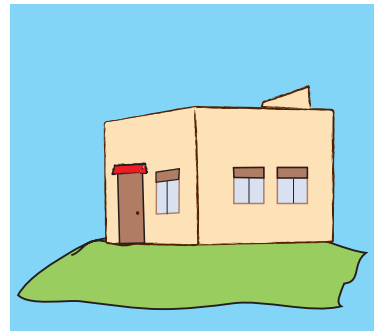



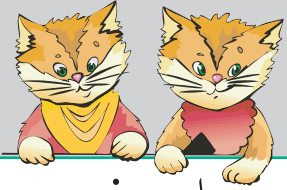

اسمي: ..... التاريخ: .....

## أَلَوِّنُ وَأَكْتُبُ الْعَدَدَ ( ٢ )

أَلَوِّنُ الْعَدَدَ (٢):

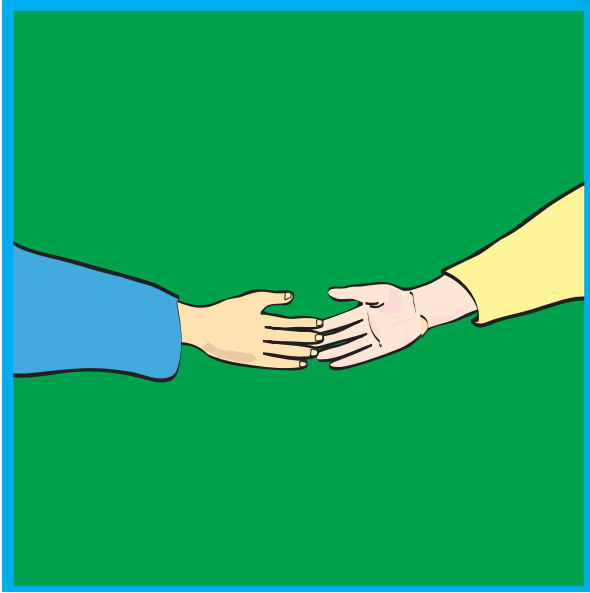

أَكْمِلْ



أَكْمِلْ



أَكْمِلْ



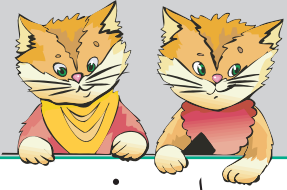

اسمي: ..... التاريخ: .....

أَلَوْنُ حَرْفِ تٍ وَأَضَعُ دَائِرَةً حَوْلَهُ فِي الْكَلِمَةِ

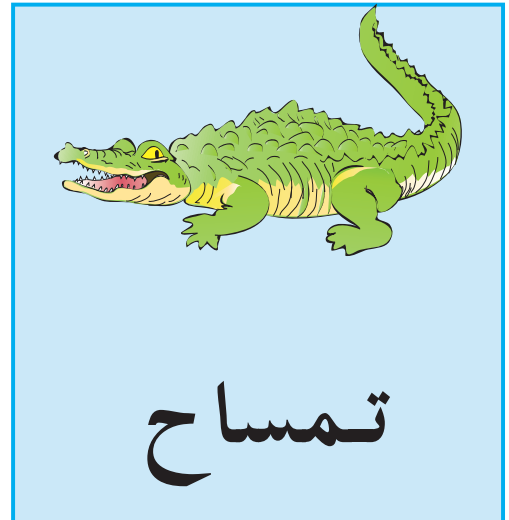
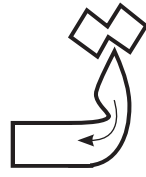
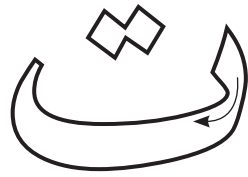
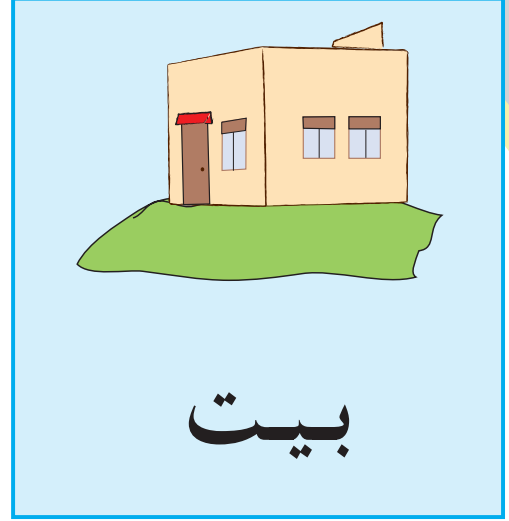

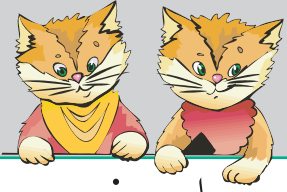

اسمي: ..... التاريخ: .....

## أَلْوَنُ وَأَرْسُمُ

أَلْوَنُ إِطَارَ الصَّوْرَةِ الَّتِي تَحْوِي (٣) أَشْيَاءَ:

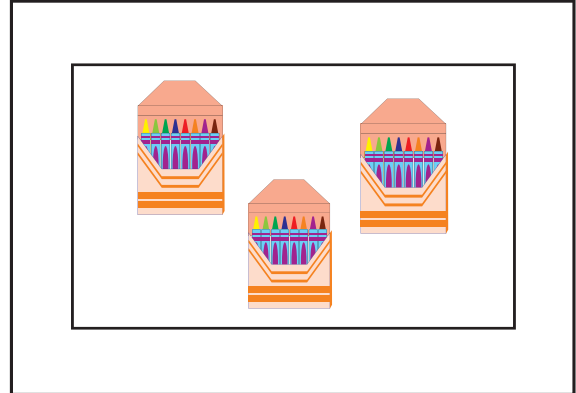
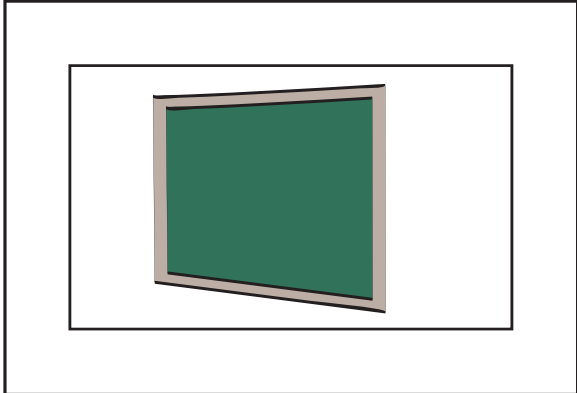
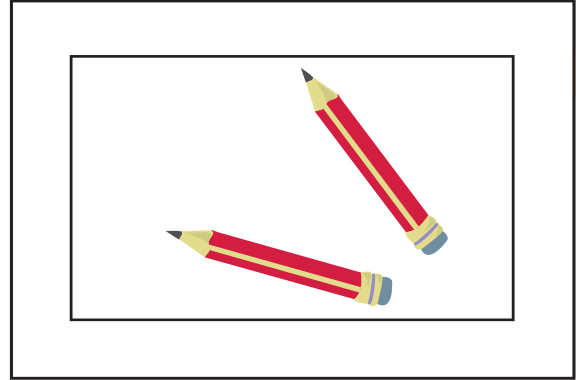
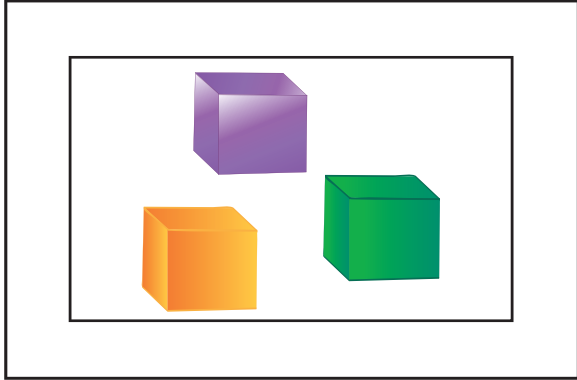

أُكْمَلُ الرَّسْمَ لِيَصْبِحَ عِدْدُ الدَّوَائِرِ (٣):

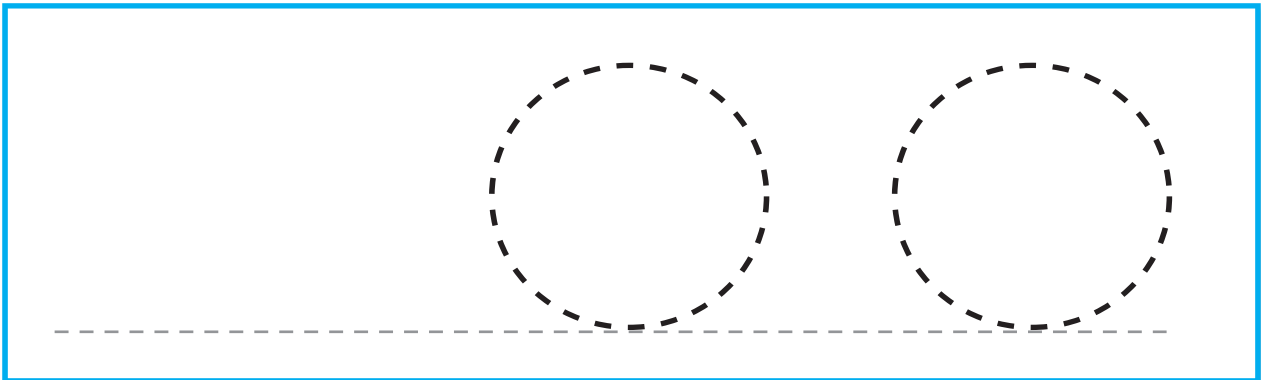

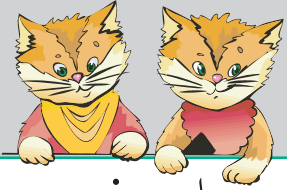

اسمي: ..... التاريخ: .....

## أرسمُ حرفَ تَ ت



تفاح  
تفاح  
تفاح.



تمر  
تمر  
تمر.

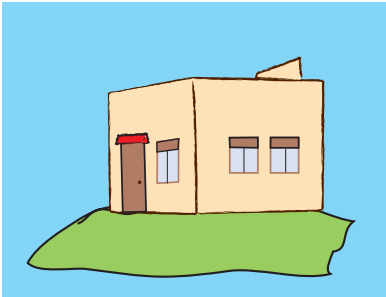

بيت  
بيت  
بيت.

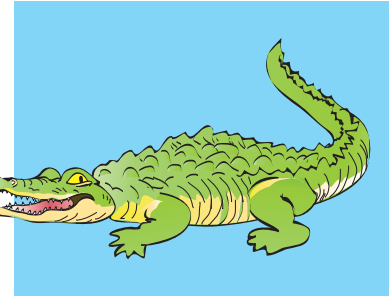

تمساح  
تمساح  
تمساح.

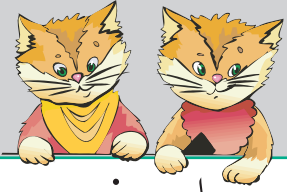

اسمي: ..... التاريخ: .....

## أَلْوَنُ وَأَصِلُ

أَبْحَثُ عَنْ (٣) وَأَلْوَنُهَا:

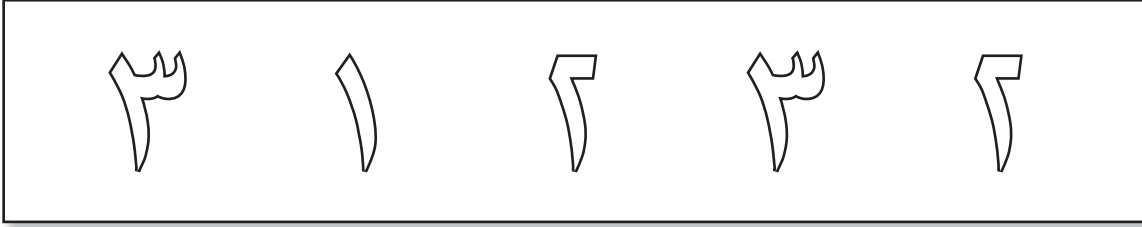

أَصِلُ بَخَطِّ بَيْنَ الصُّورَةِ وَعَدَدِ الْأَشْيَاءِ فِيهَا:

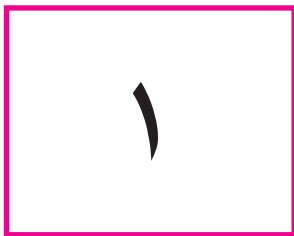
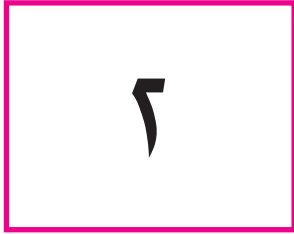

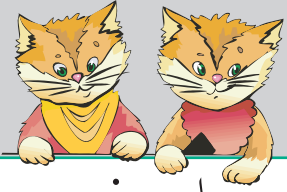

اسمي: ..... التاريخ: .....

## أصل الصورة بالحرف الذي تبدأ به

رَ

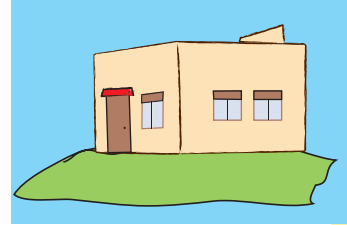

يَا

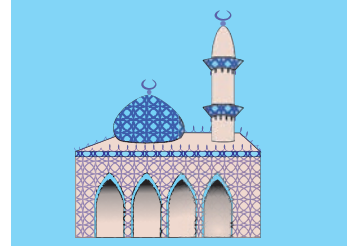

بَا



يَا

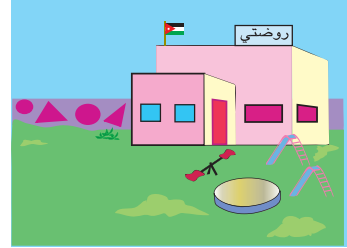

مَا



وَا

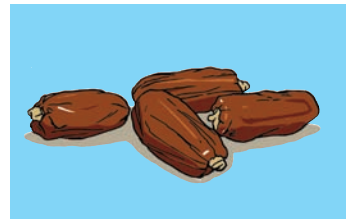

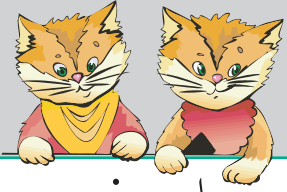

اسمي: ..... التاريخ: .....

## أَلَوْنُ وَأَكْتُبُ الْعَدَدَ ( ٣ )

أَلَوْنُ الْعَدَدِ (٣):

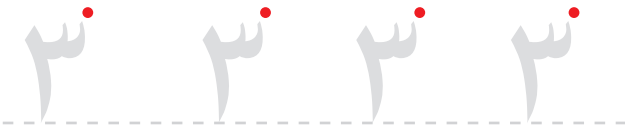
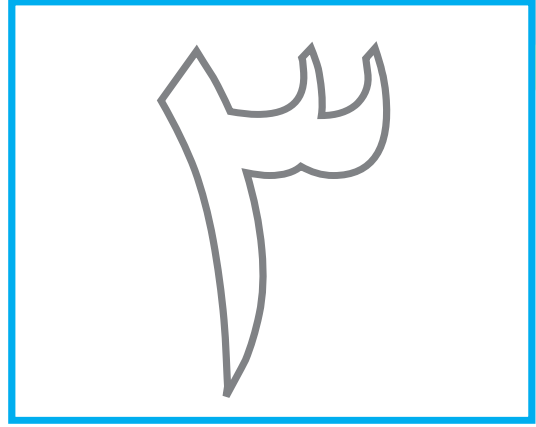
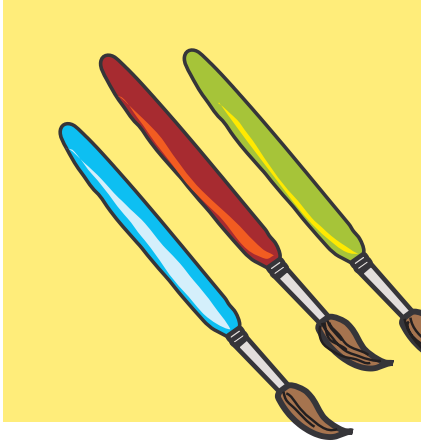

أَكْمِلْ



أَكْمِلْ



أَكْمِلْ

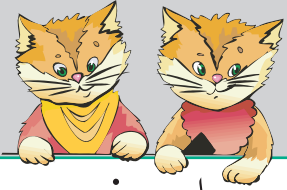

اسمي: ..... التاريخ: .....

أَعِدُّ وَأَرْسُمُ

أَعِدُّ، وَأَرْسُمُ العدد:

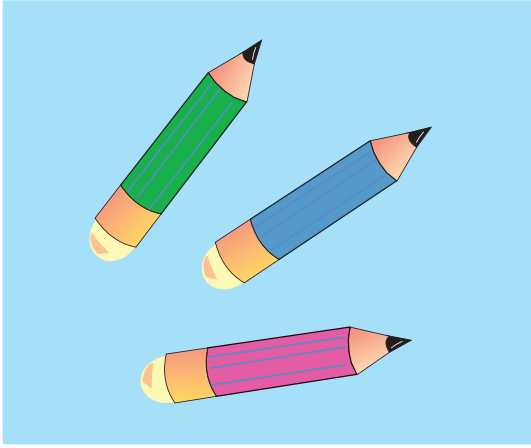

٣ ٢ ١



٣ ٢ ١



٣ ٢ ١



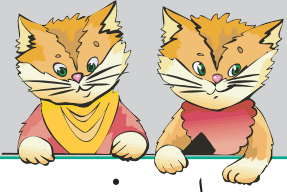

اسمي: ..... التاريخ: .....

## أَعِدُّ وَأُلَوِّنُ

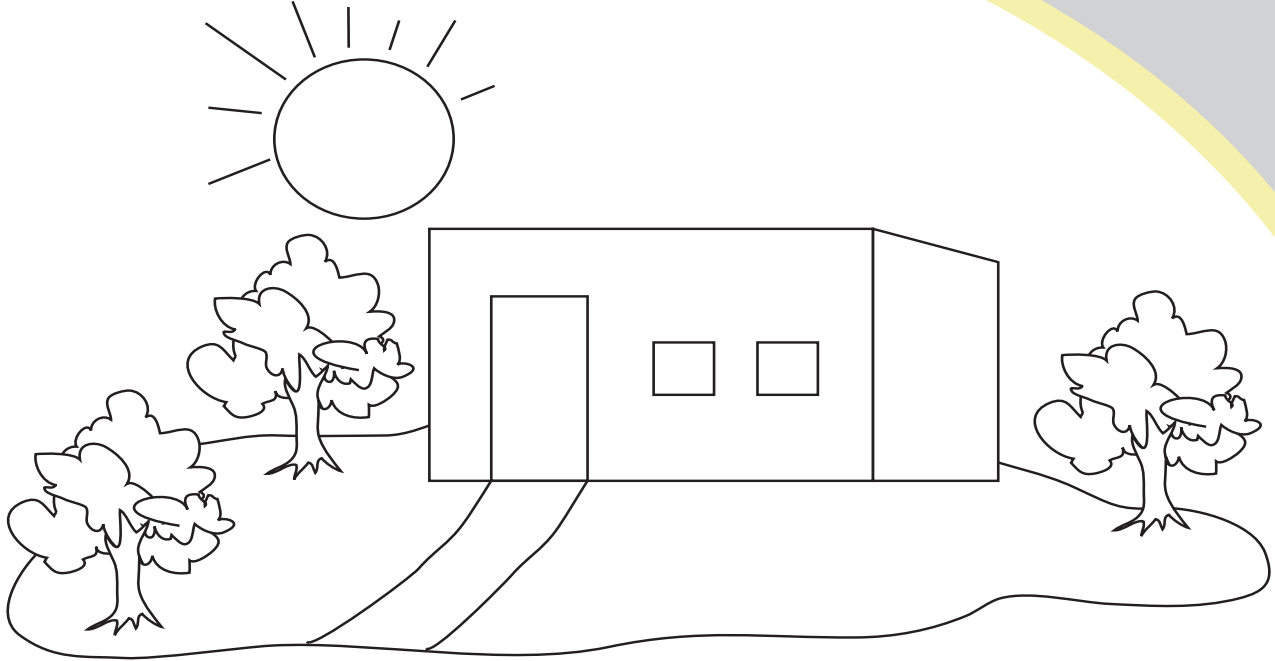

.....



عدد

.....

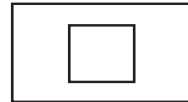

عدد

.....

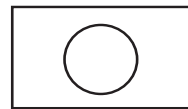

عدد

.....

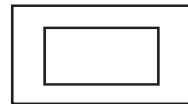

عدد

- أُلَوِّنُ المَرَبَّعاتِ □ باللونِ الأحمرِ.
- أُلَوِّنُ المَسْتطِيلاتِ □ باللونِ الأزرقِ.
- أُلَوِّنُ الدَّوائِرَ ○ باللونِ الأصفرِ.

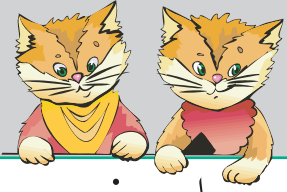

اسمي: ..... التاريخ: .....

## أرسمُ حروفي



وَرْدَةٌ

رِدَةٌ

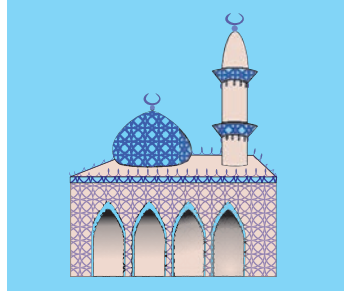

مَسْجِدٌ

سِجْدٌ

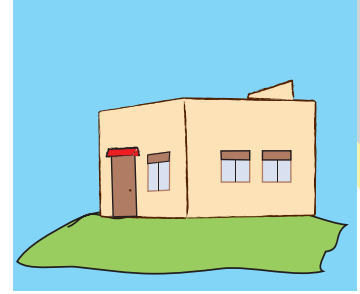

بَيْتٌ

يْتُ



تَمْرٌ

مَرٌ

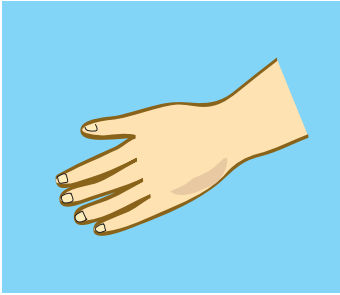

يَدٌ

دٌ

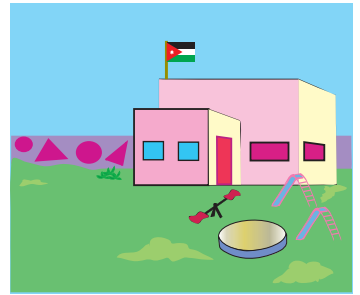

رَوْضَةٌ

وَضَةٌ

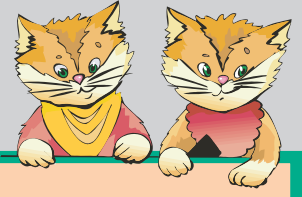

# اسرتي



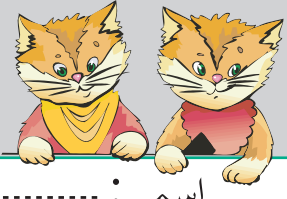

اسمي: ..... التاريخ: .....

## أَصِلُ الصَّغِيرَ بِجَمَاعَتِهِ

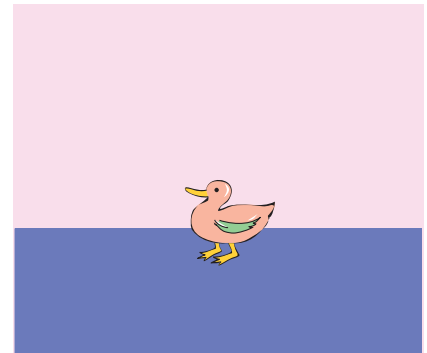
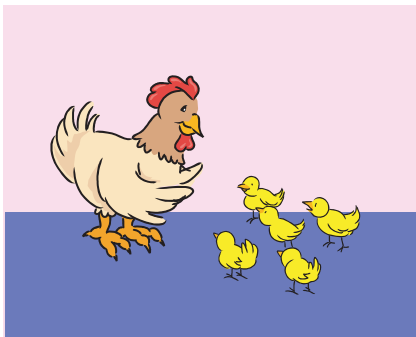
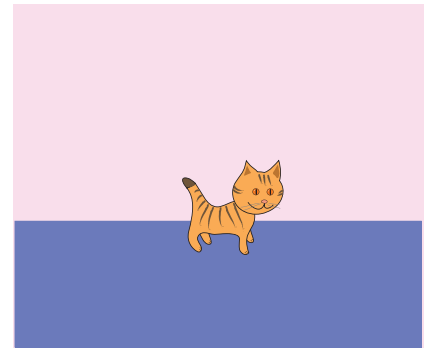
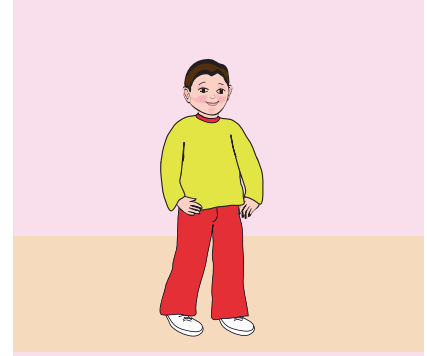
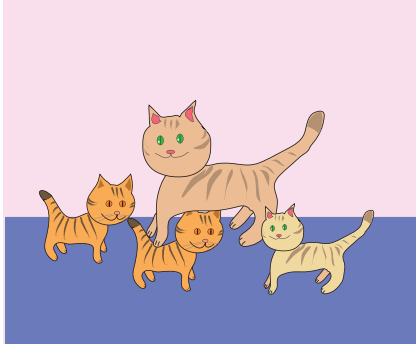
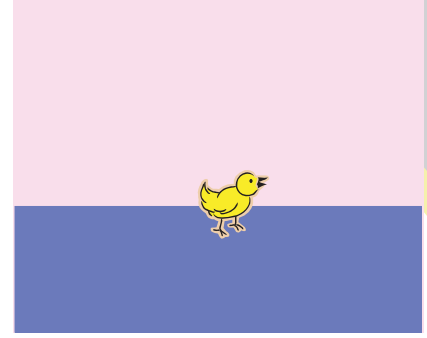
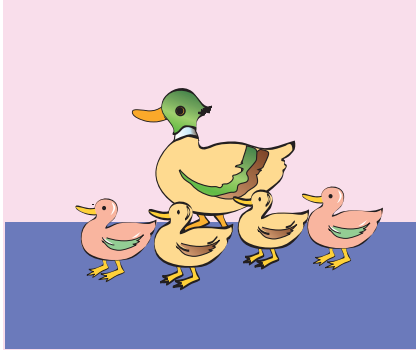

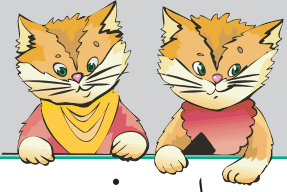

اسمي: ..... التاريخ: .....

## أصل الصورة بالكلمة

رأس

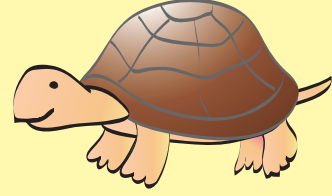

سمك

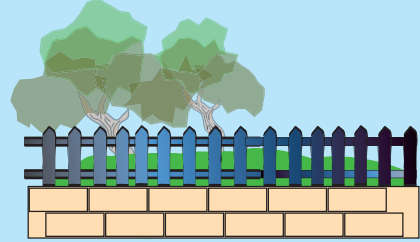

سلحفاة

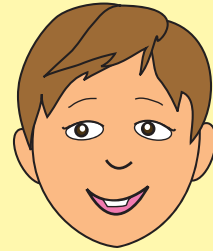

سياج

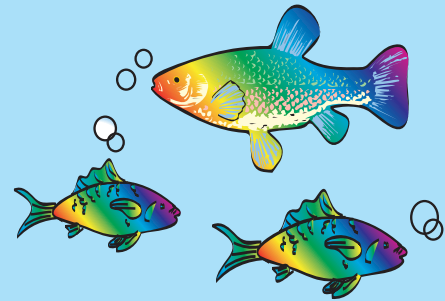

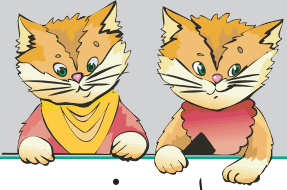

اسمي: ..... التاريخ: .....

أَلَوْنُ حَرْفٍ لِسَ لِسَ وَأَضَعُ دَائِرَةً حَوْلَهُ فِي الْكَلِمَةِ



لِسَ

لِسَ

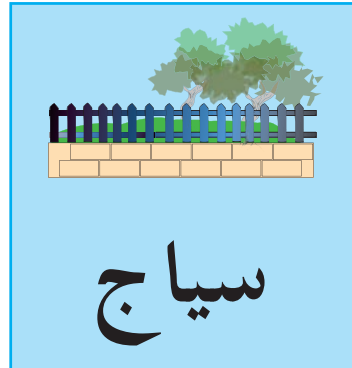
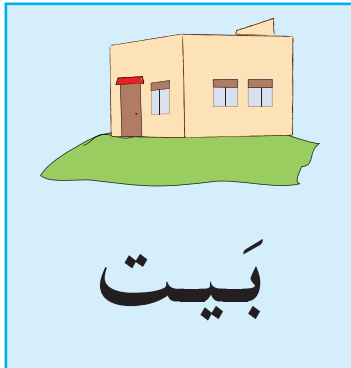

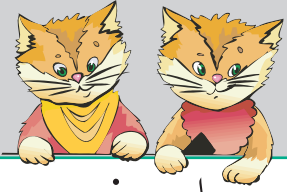

اسمي: ..... التاريخ: .....

## ألون وأضع دائرة

■ ألون (٤) أشياء من كل مجموعة:

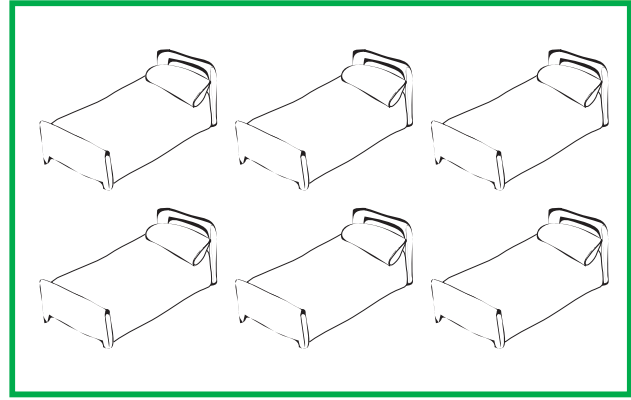
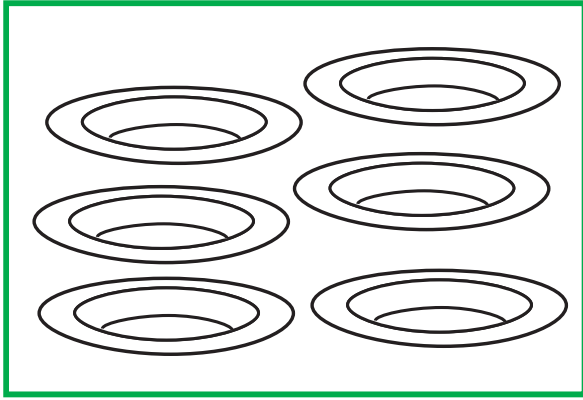

■ أضع دائرة حول الصورة التي تحوي العدد نفسه:

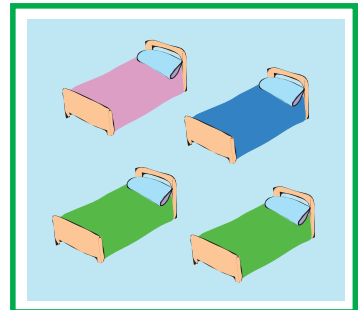
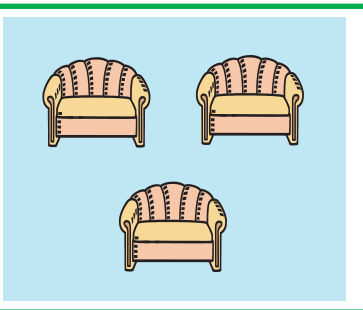
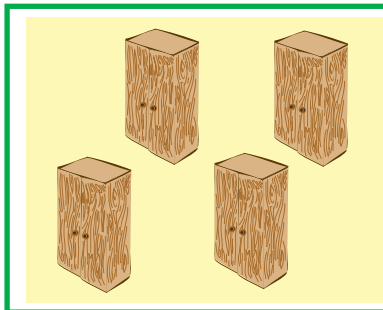
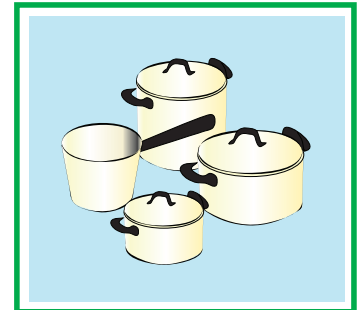
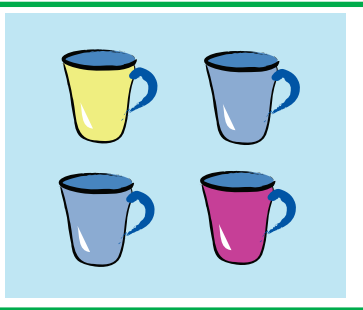
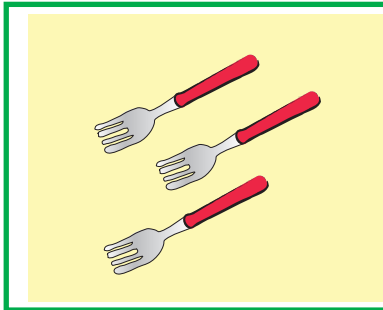

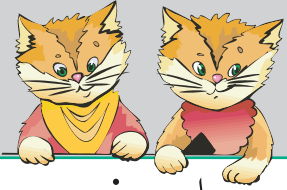

اسمي: ..... التاريخ: .....

## أرسمُ حرفَ س

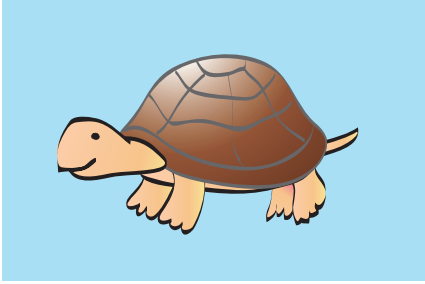

سـلحفاة

سـلحفاة

لحفاة .

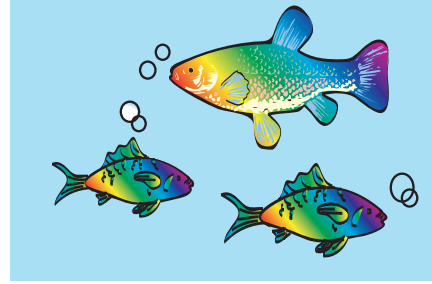

سـمك

سـمك

مك .

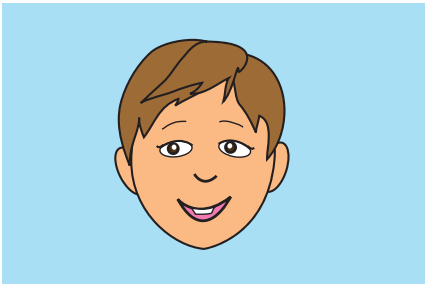

رأس

رأس

رأ .

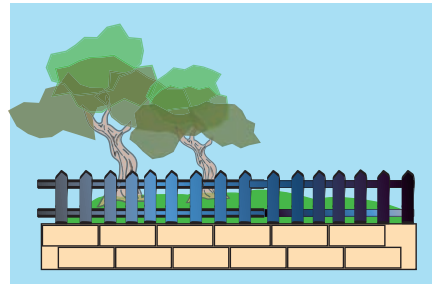

سـياج

سـياج

ياج .



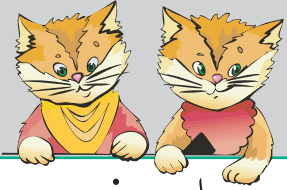

اسمي: ..... التاريخ: .....

## أَلَوْنُ وَأَكْتُبُ الْعَدَدَ ( ٤ )

أَلَوْنُ الْعَدَدِ (٤):

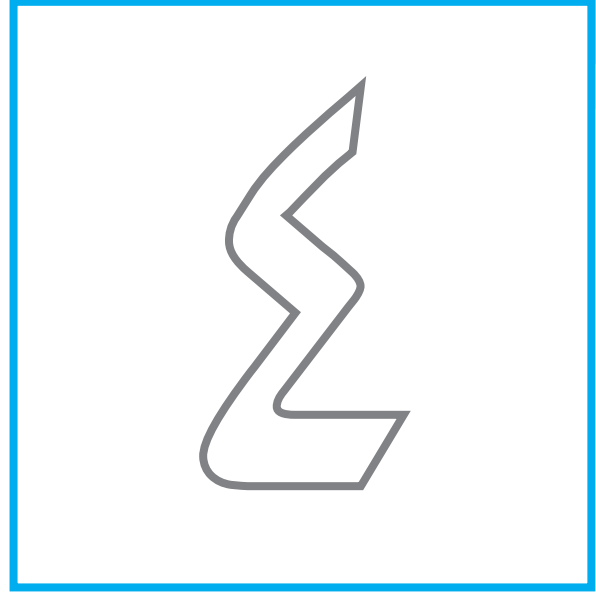

أَكْمِلْ



أَكْمِلْ



أَكْمِلْ

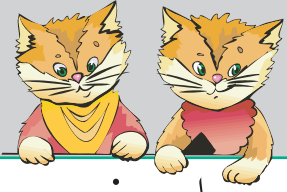

اسمي: ..... التاريخ: .....

## أصل الصورة بالحرف الذي تبدأ به

و

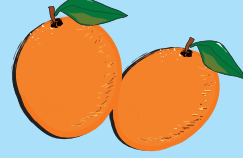

ب

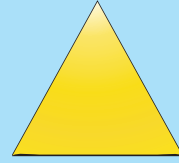

م



يا

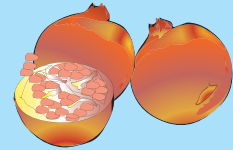

تا



س

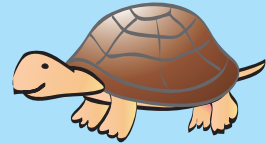

ر



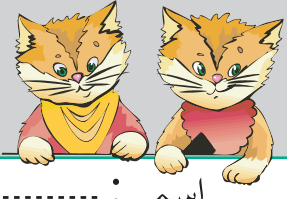

اسمي: ..... التاريخ: .....

## أَلْوَنُ وَأَضَعُ دَائِرَةً

■ أَلْوَنُ (٥) أَشْيَاءَ مِنْ كُلِّ مَجْمُوعَةٍ:

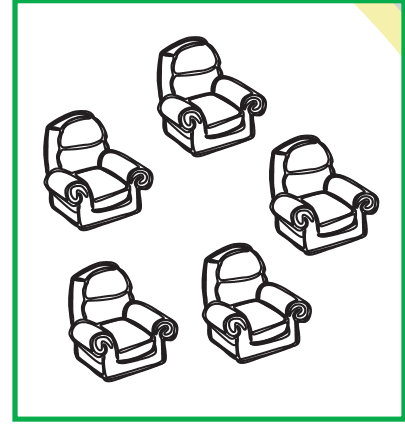
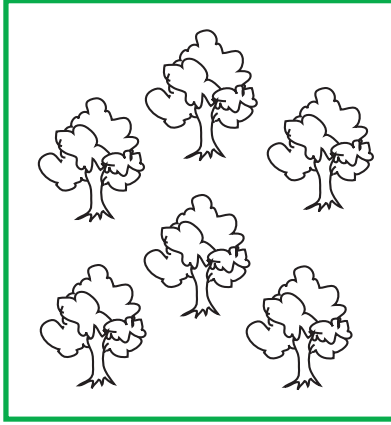

■ أَضَعُ دَائِرَةً حَوْلَ الصُّورَةِ الَّتِي تَحْوِي الْعَدَدَ نَفْسَهُ:

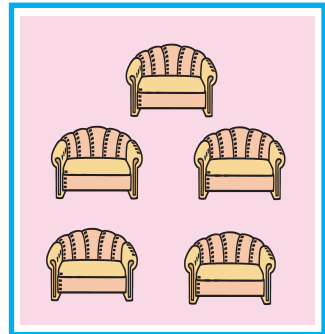
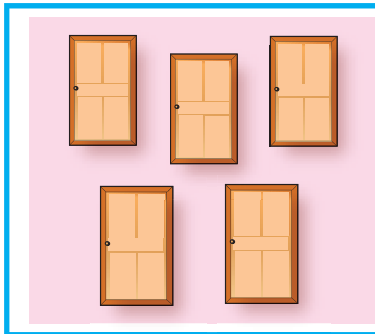
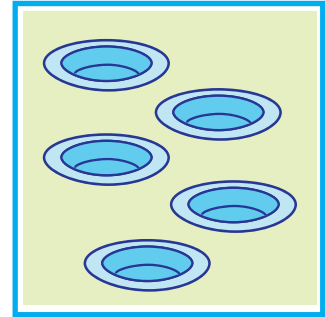
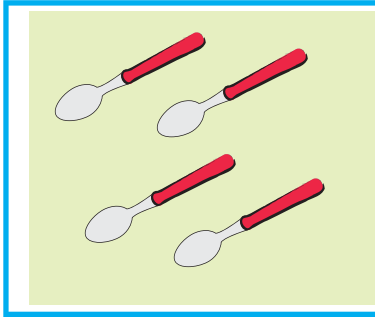

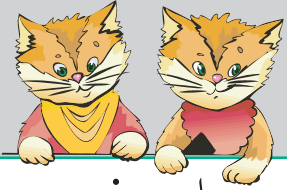

اسمي: ..... التاريخ: .....

## أرسم حُرُوفي



وُرُود

وُرُود

رود .

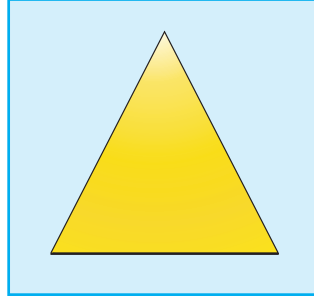

مُثلث

مُثلث

ثلث .

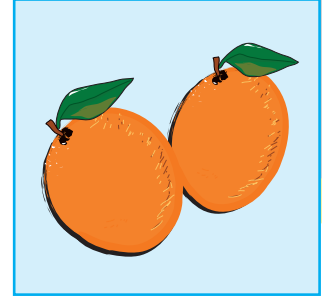

بُرُتقال

بُرُتقال

رتقال .

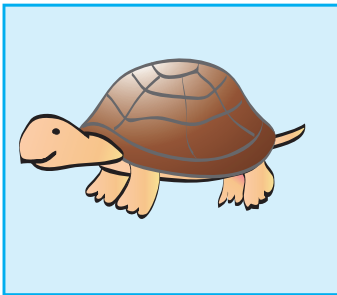

سُلحفاة

سُلحفاة

لحفاة .

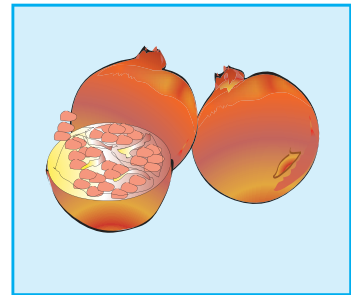

رُمان

رُمان

مان .

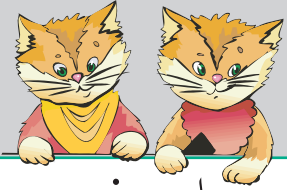

اسمي: ..... التاريخ: .....

## ألون وأكتب العدد ( ٥ )

ألون العدد (٥):

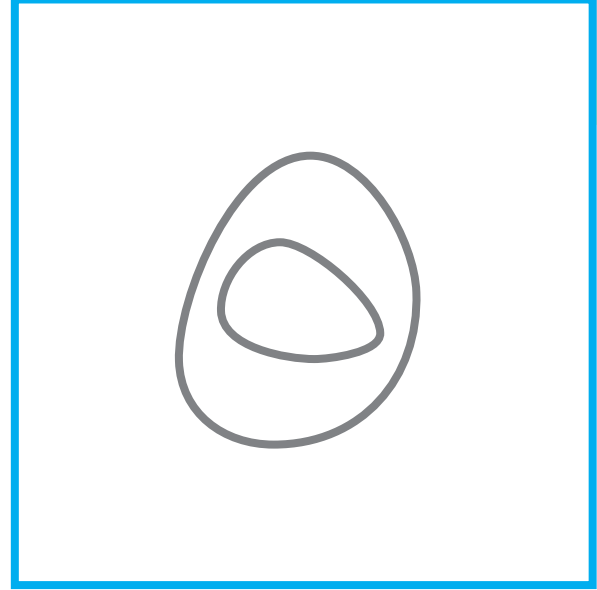
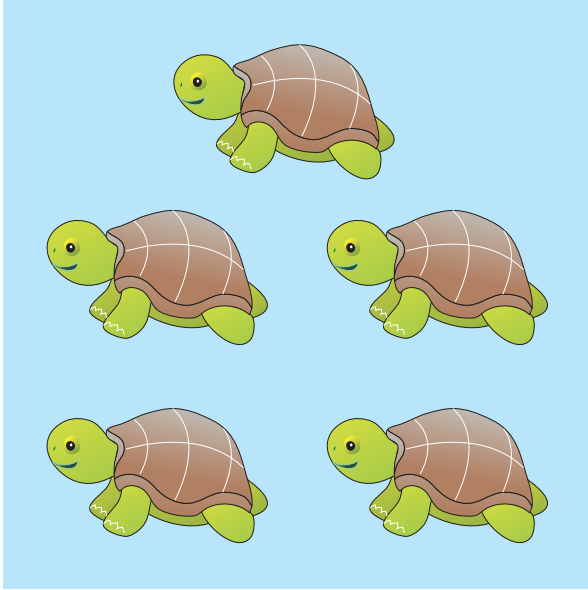

أَكْمِلْ



أَكْمِلْ



أَكْمِلْ

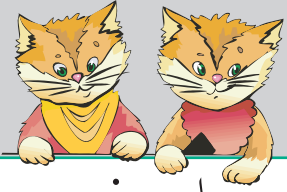

اسمي: ..... التاريخ: .....

## أصل الصورة بالكلمة

وُرود

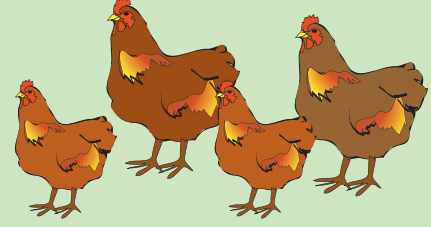

دببة



دجاج



دمية



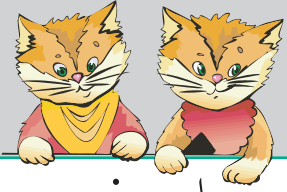

اسمي: ..... التاريخ: .....

## أَحْضِرُ وَأَصِلُ

### أَحْضِرُ (٦):

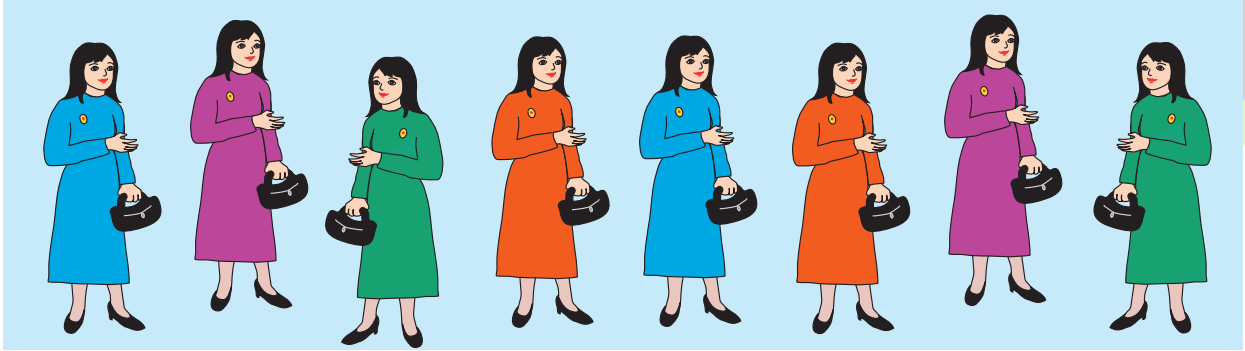

### أَصِلُ بَخَطِّ بَيْنَ الْمَجْمُوعَاتِ الْمَتَسَاوِيَةِ:

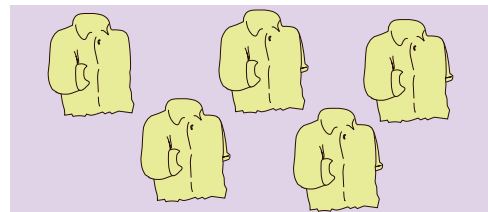
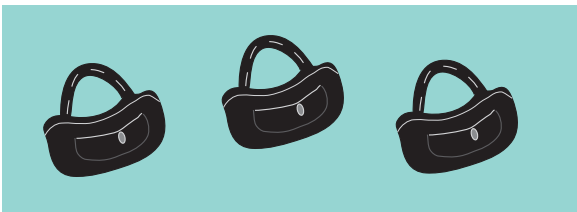
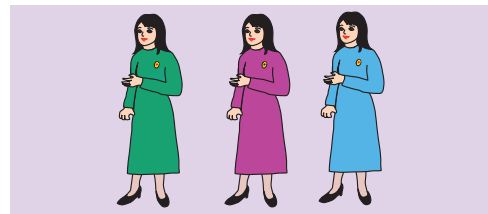
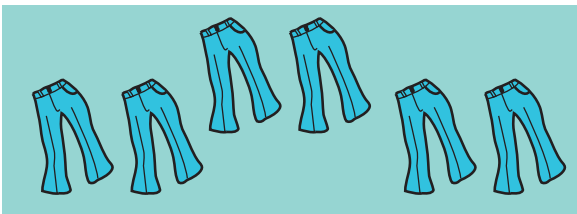
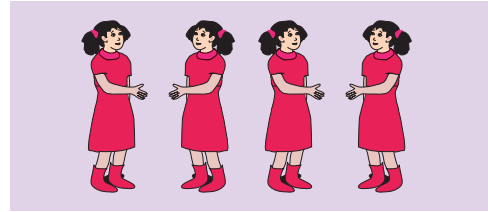
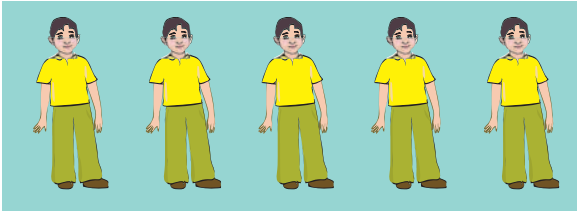
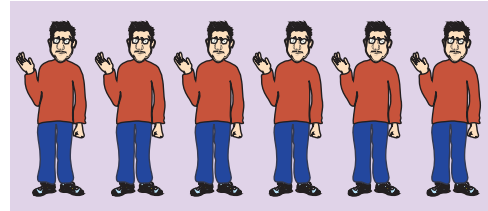
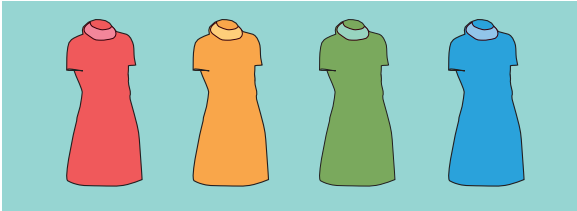

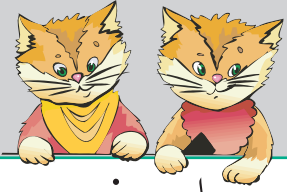

اسمي: ..... التاريخ: .....

## أَلُوْنُ حَرْفِ دَ وَأَضَعُ دَائِرَةً حَوْلَهُ فِي الْكَلِمَةِ

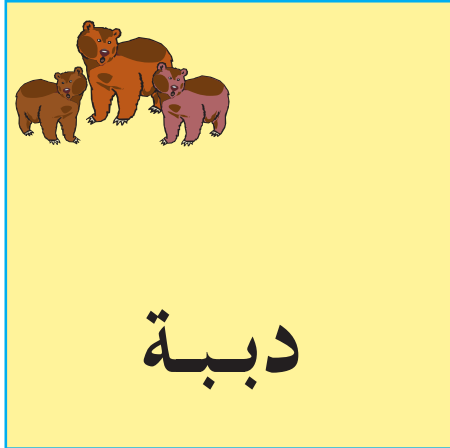



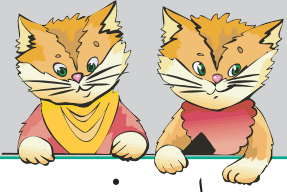

اسمي: ..... التاريخ: .....

## أَلَوْنُ وَأَكْتُبُ الْعِدَدَ ( ٦ )

أَلَوْنُ الْعِدَدَ (٦):

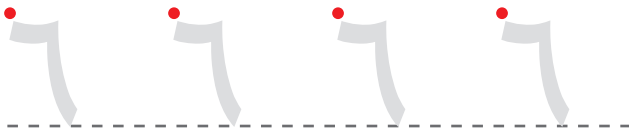
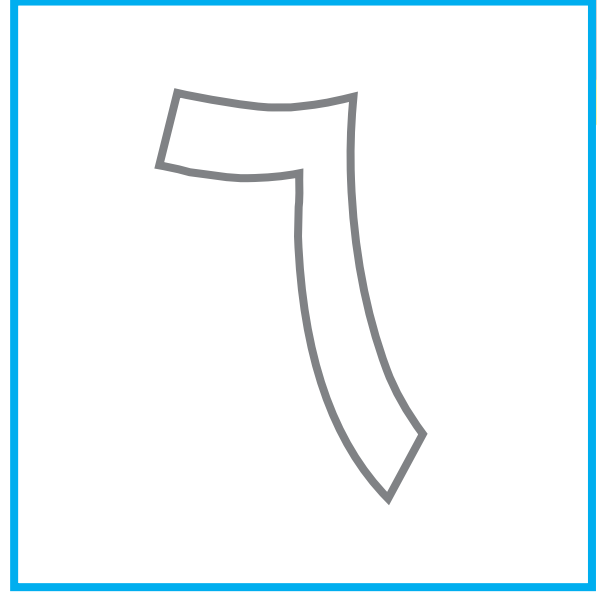
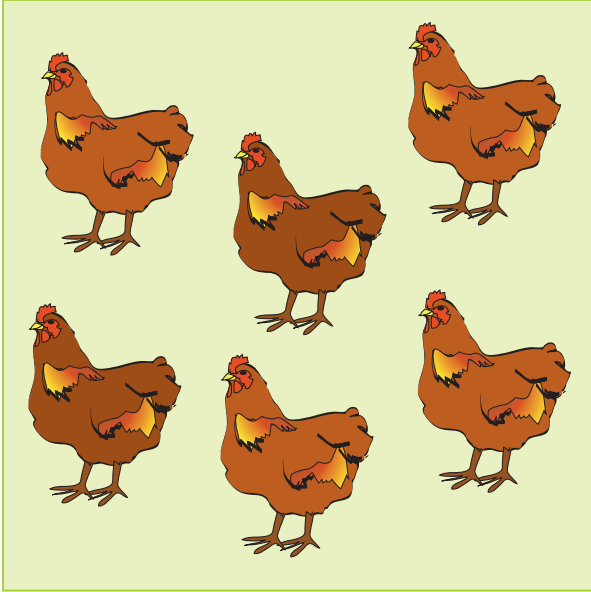

أَكْمِلُ



أَكْمِلُ



أَكْمِلُ



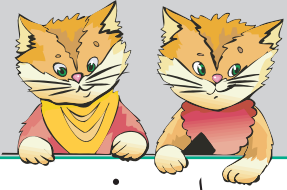

اسمي: ..... التاريخ: .....

## أرسم حرف د



دُمِيَّة

دُمِيَّة

مِيَّة

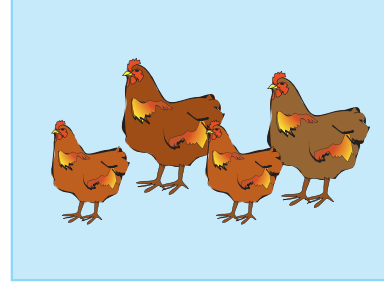

دَجَاج

دَجَاج

جَاج



وُرُود

وُرُود

وُرُود

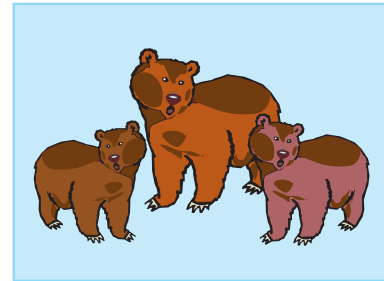

دَبِيَّة

دَبِيَّة

بِيَّة

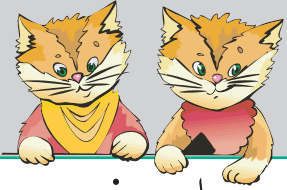

اسمي: ..... التاريخ: .....

## أكتشف وأرسم وألون

■ أكتشف النمط وأرسم:

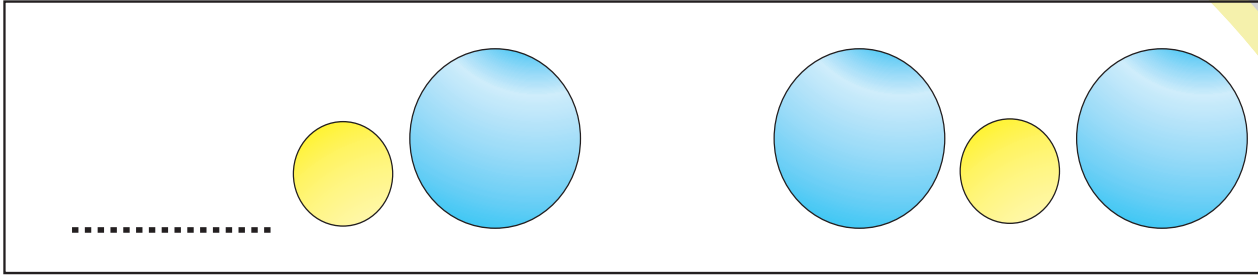

■ أكتشف النمط وألون:

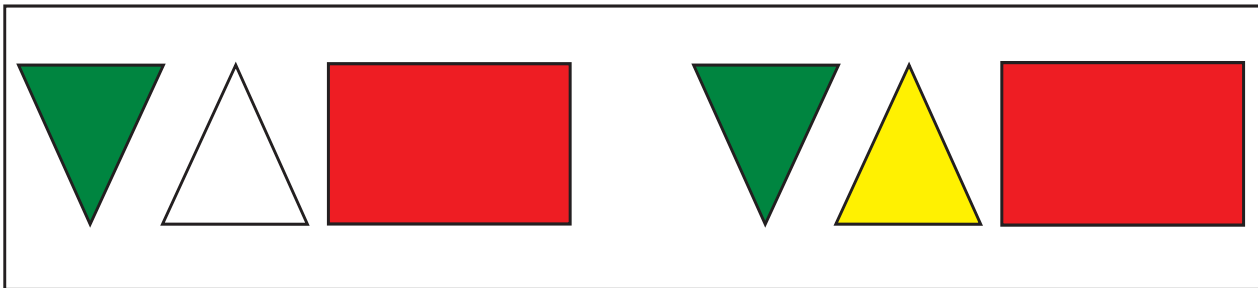

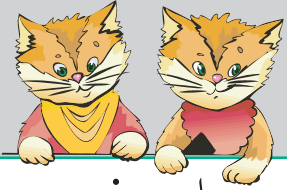

اسمي: ..... التاريخ: .....

## أصل الصورة بالحرف الذي تبدأ به

و

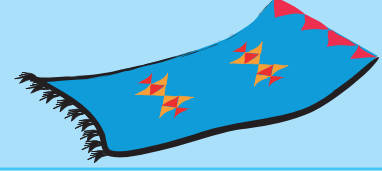

ب

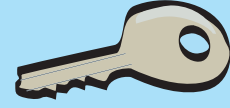

م

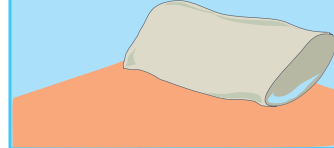

ا



ر

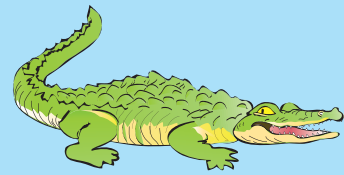

ت

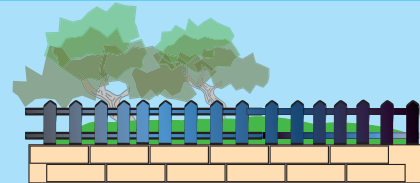

د



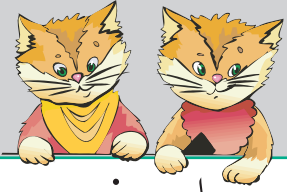

اسمي: ..... التاريخ: .....

## أرسم حروفي



مِفْتَاح

مِفْتَاح

مِفْتَاح .

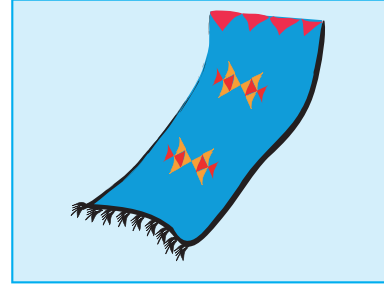

بِسَاط

بِسَاط

بِسَاط .

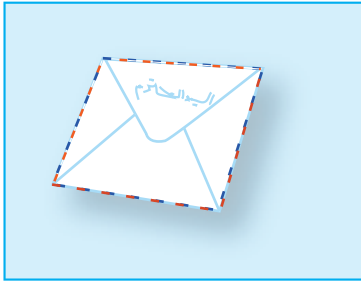

رِسَالَة

رِسَالَة

رِسَالَة .

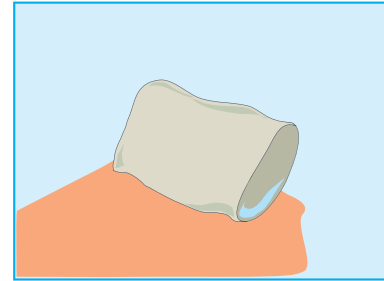

وِسَادَة

وِسَادَة

وِسَادَة .

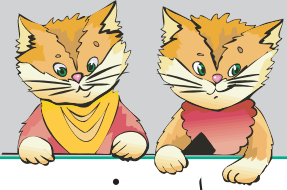

اسمي: ..... التاريخ: .....

## أرسم حروفي

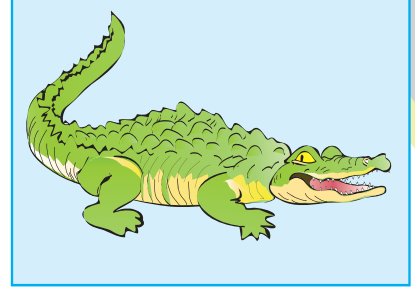
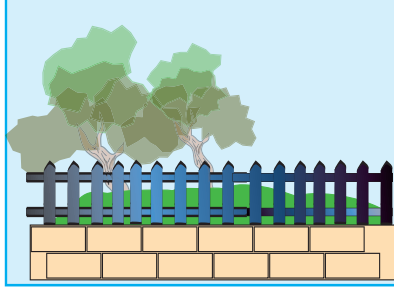
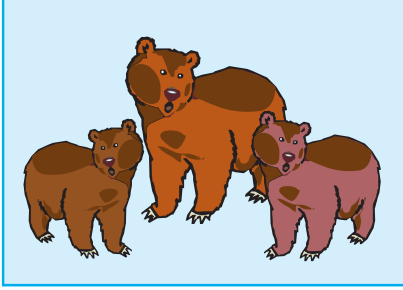

دببة

سياج

تمساح

دببة

سياج

تمساح

ببة

ياج

مساح

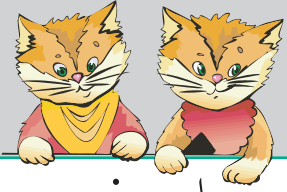

اسمي: ..... التاريخ: .....

## أَعِدُّ وَأَلَوِّنْ



أَعِدُّ: ■

عدد — .....  

عدد — .....  

عدد — .....  

عدد — .....  



أَلَوِّنْ المَرَبَّعاتِ □ باللونِ الأحمر. ■

أَلَوِّنْ المَسْتطِيلاتِ □ باللونِ الأزرق. ■

أَلَوِّنْ الدَّوائِرَ ○ باللونِ الأصفر. ■



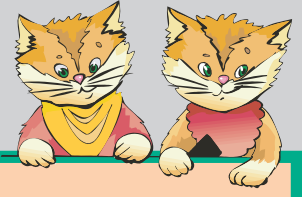



# حيواناتي



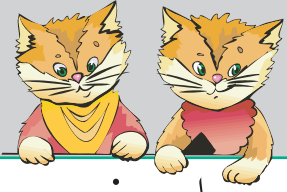

اسمي: ..... التاريخ: .....

## أَحْصِرْ وَأُكْمَلْ

أَحْصِرْ مِنْ كُلِّ مَجْمُوعَةٍ (٧) حَيَوَانَاتٍ:

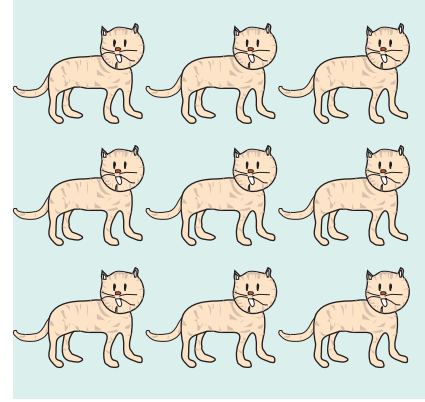
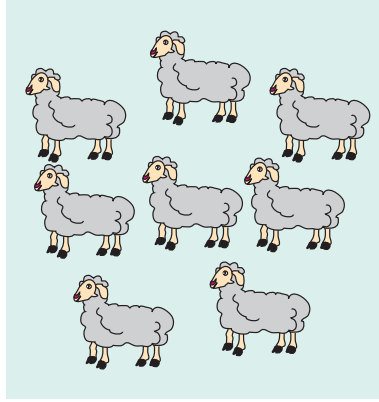
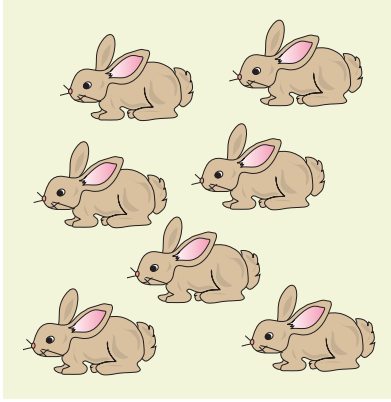

أُكْمَلْ عُنَاصِرَ الْمَجْمُوعَاتِ الْآتِيَةِ لِصَبْحِ الْعَدْدِ (٧):

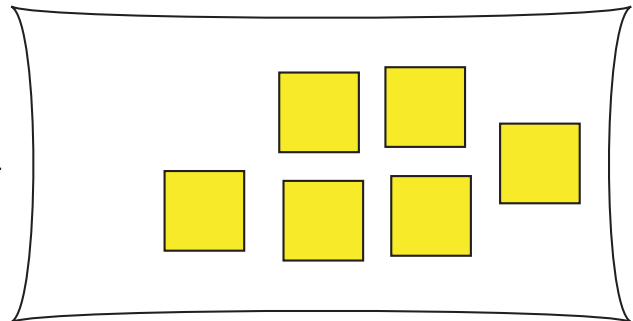
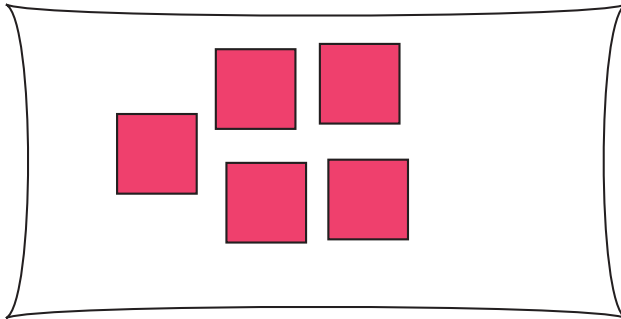
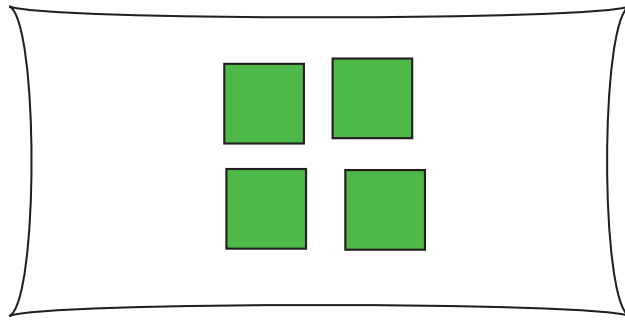

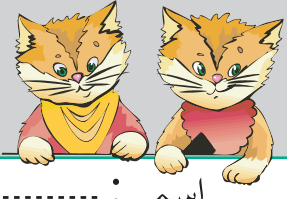

اسمي: ..... التاريخ: .....

## أَصِلُ الصَّوْرَةَ بِالْكَلِمَةِ

حِصَان

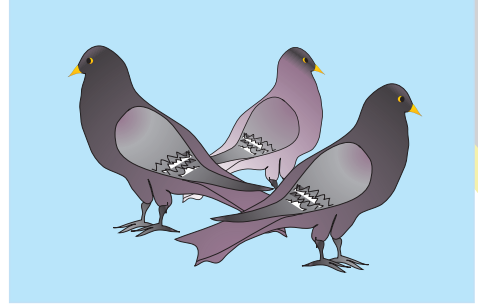

حُبُوب

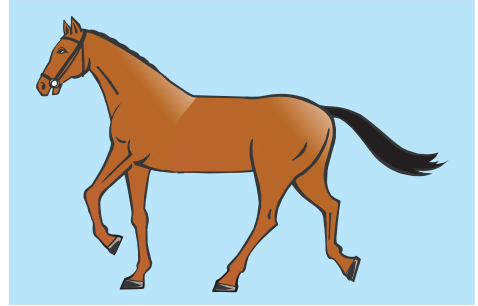

تِمْسَاح



حَمَام

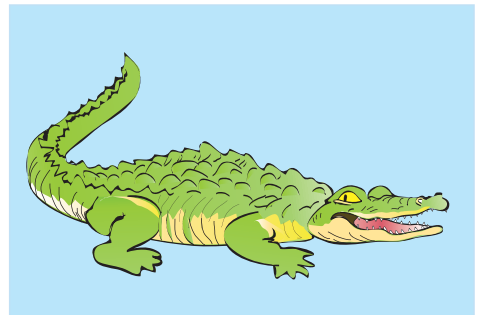

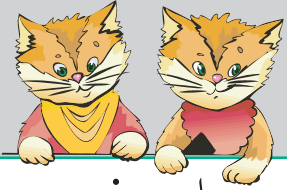

اسمي: ..... التاريخ: .....

## أصل الصورة بالعدد

٦

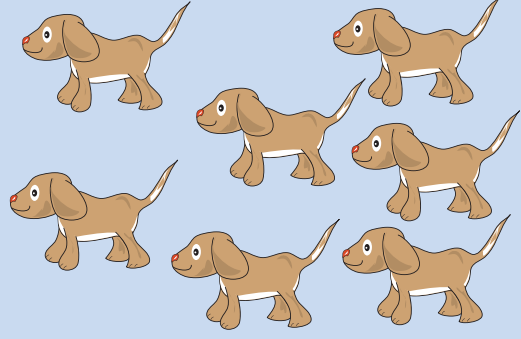

٧

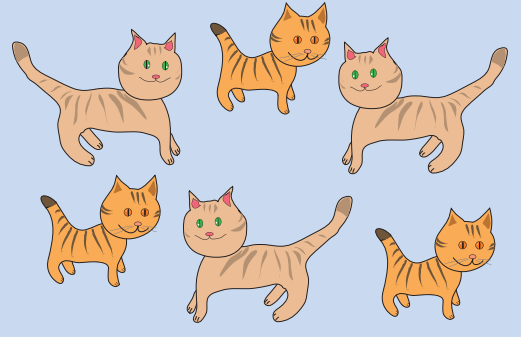

٤

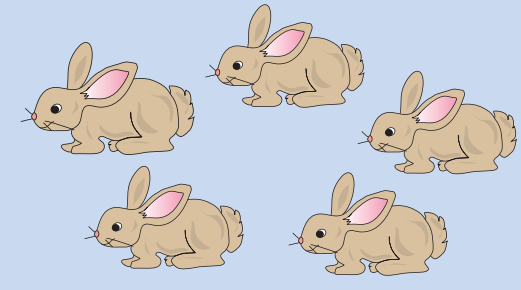

٥

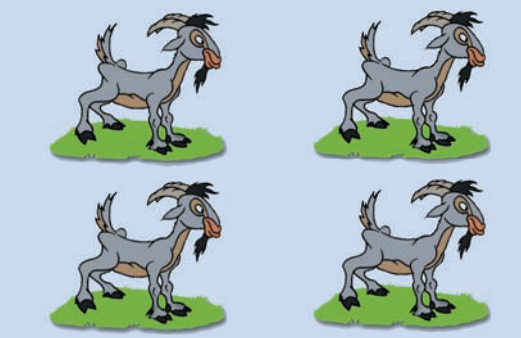

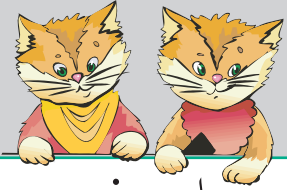

اسمي: ..... التاريخ: .....

أَلَوْنُ حَرْفِ ح ح وَأَضَعُ دَائِرَةً حَوْلَهُ فِي الْكَلِمَةِ

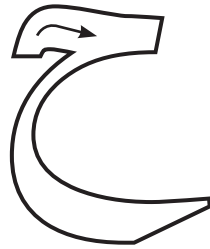
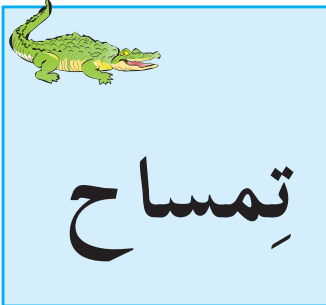

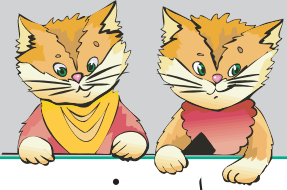

اسمي: ..... التاريخ: .....

## ألون وأكتب العدد ( ٧ )

ألون العدد (٧):

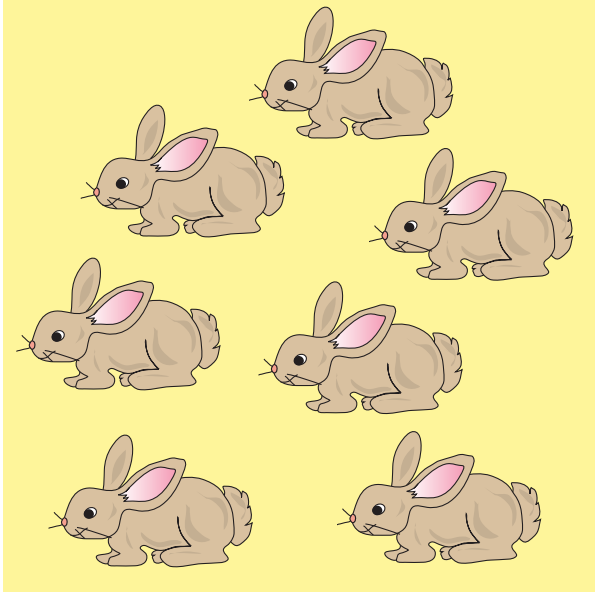

أكمل



أكمل



أكمل



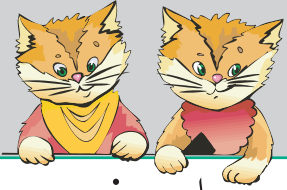

اسمي: ..... التاريخ: .....

## أرسمُ حرفَ ح ح

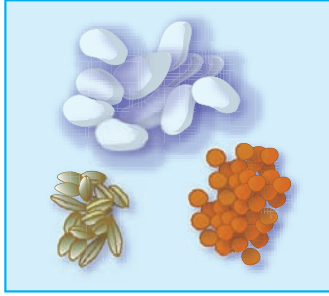

حُبُوب

حُبُوب

بُوب

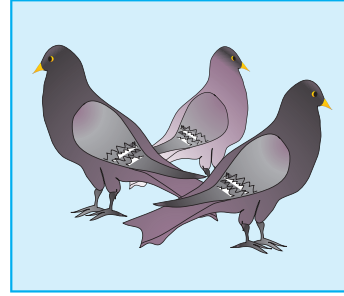

حَمَام

حَمَام

مَام

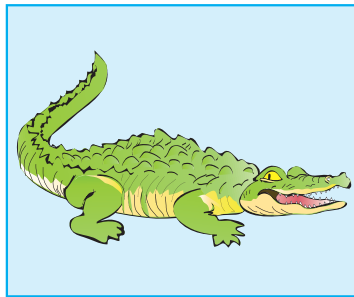

تِمْسَاح

تِمْسَاح

تِمْسَا

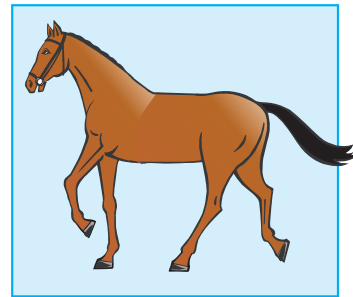

حِصَان

حِصَان

صَان

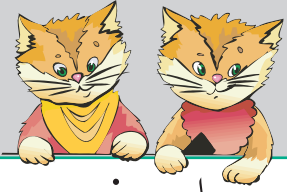

اسمي: ..... التاريخ: .....

## أصل الصورة بالكلمة

نحل



نجوم



حصان

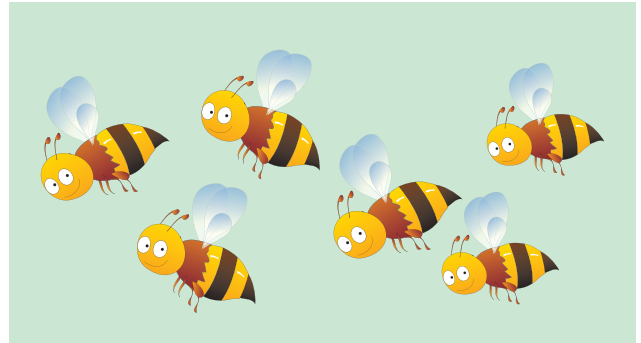

نصف

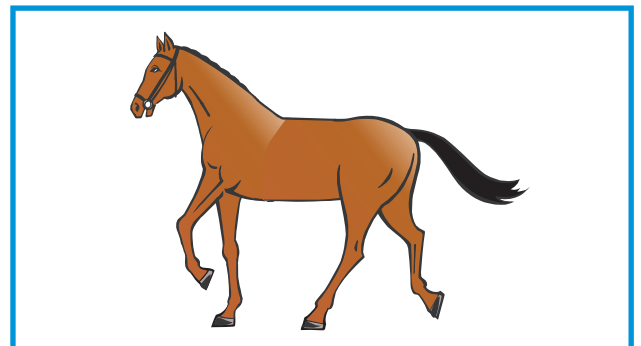



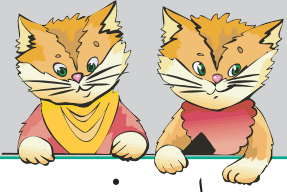

اسمي: ..... التاريخ: .....

## أَحْضَرُ وَأَلْوَنُ

■ أَحْضَرُ مِنْ كُلِّ مَجْمُوعَةٍ (٨) طُيُور:

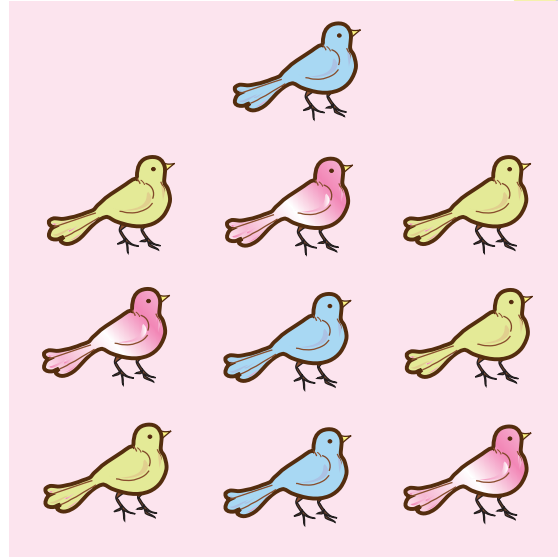
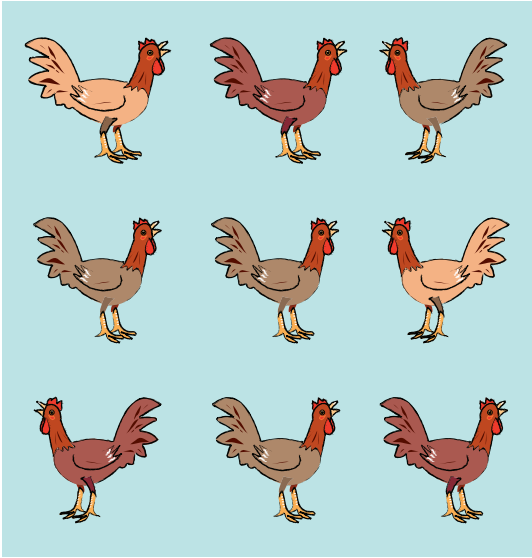

■ أَلْوَنُ مِنْ كُلِّ مَجْمُوعَةٍ (٨) أَجْزَاء:

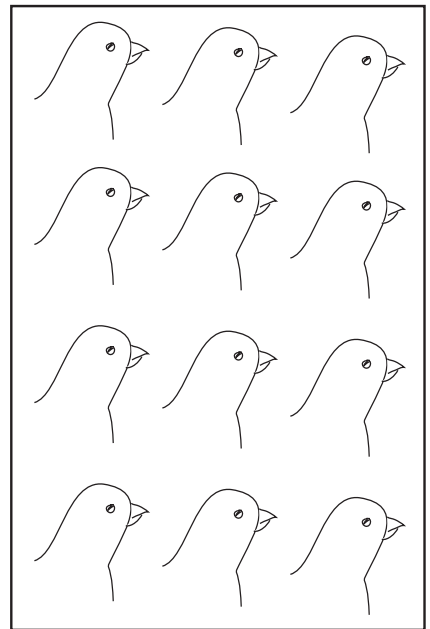
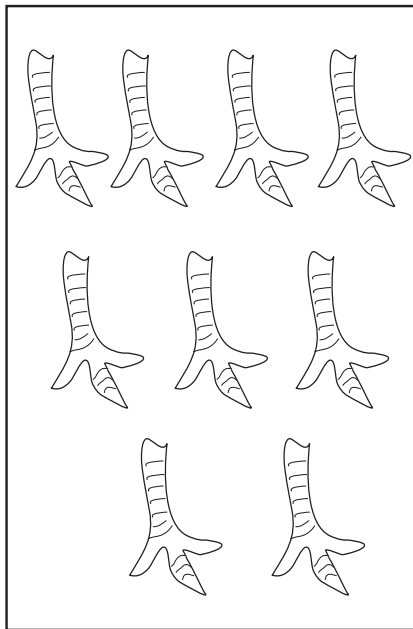
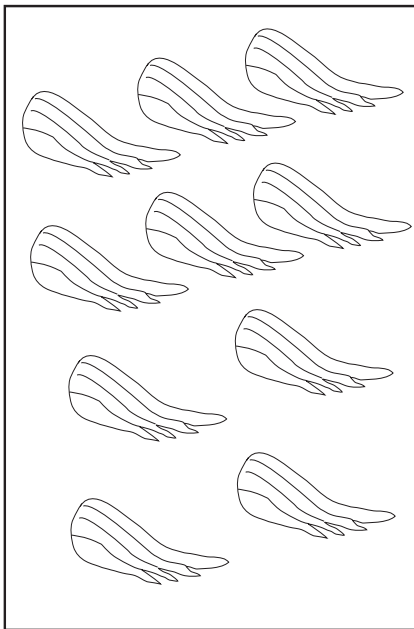

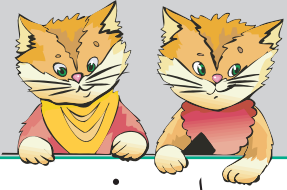

اسمي: ..... التاريخ: .....

## أَلْوَنُ حَرْفَ نَ نْ وَأَضَعُ دَائِرَةً حَوْلَهُ فِي الْكَلِمَةِ

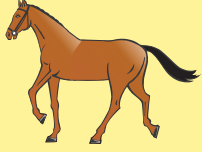

حِصَان



نُجُوم



بَيْت

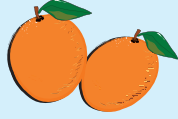

بُرْتُقَال

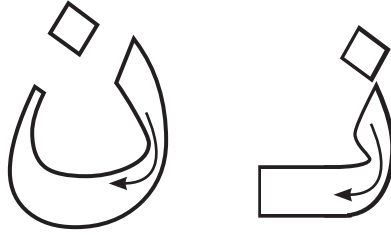

تَمْر



تِمْسَاح



نِصْف



نَحْل

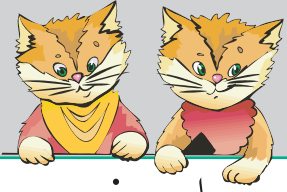

اسمي: ..... التاريخ: .....

## أصل الصورة بالعدد

٧

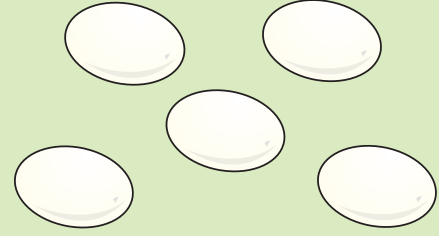

٥

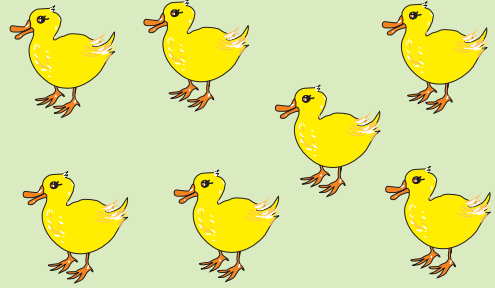

٨

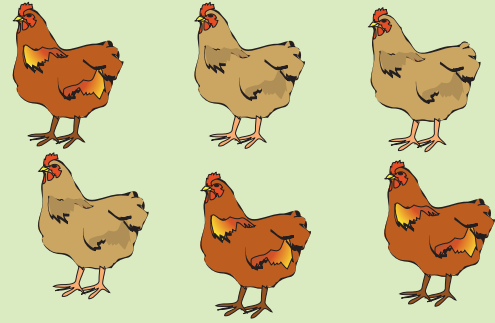

٦

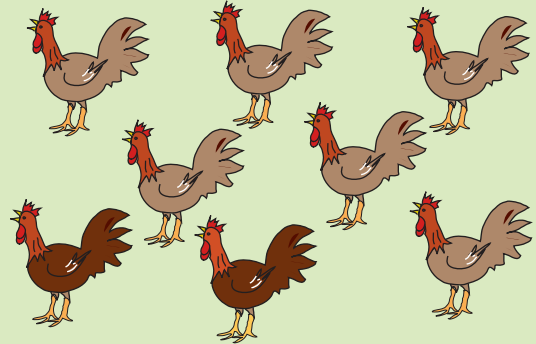

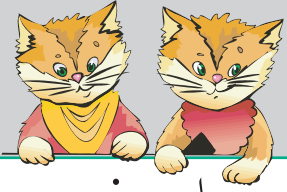

اسمي: ..... التاريخ: .....

## أرسمُ حرفَ ن



نجوم

نجوم

جوم .

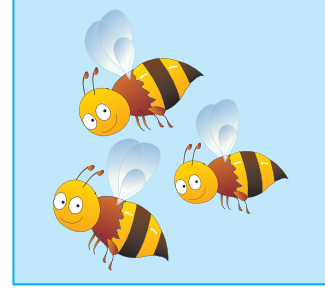

نحل

نحل

حل .

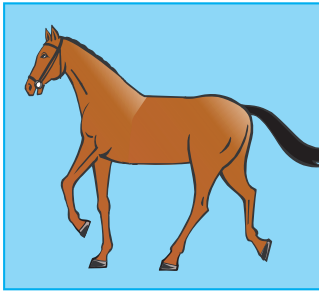

حصان

حصان

صا .



نصف

نصف

صف .

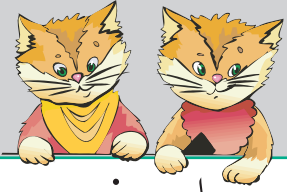

اسمي: ..... التاريخ: .....

## أصل الصورة بالكلمة

لَبْوَةٌ

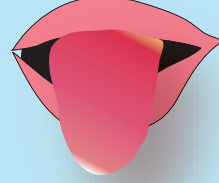

غزال

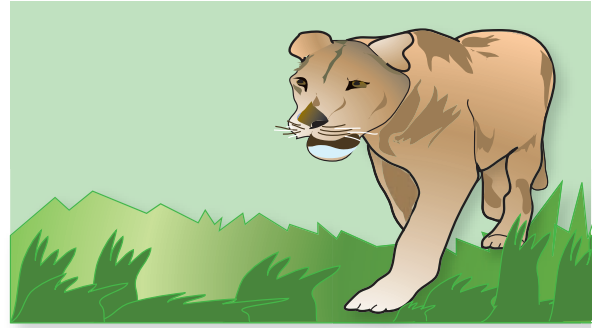

لِسَان

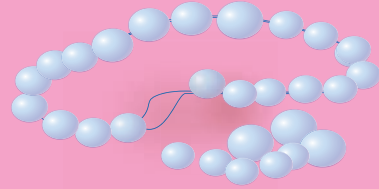

لُؤْلُؤٌ

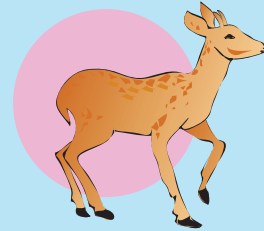

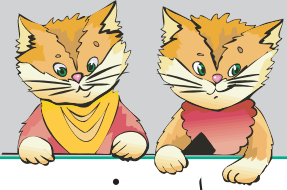

اسمي: ..... التاريخ: .....

## أَلَوْنُ وَأَكْتُبُ الْعَدَدَ (٨)

أَلَوْنُ الْعَدَدَ (٨):

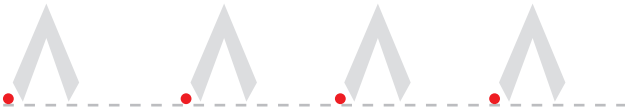
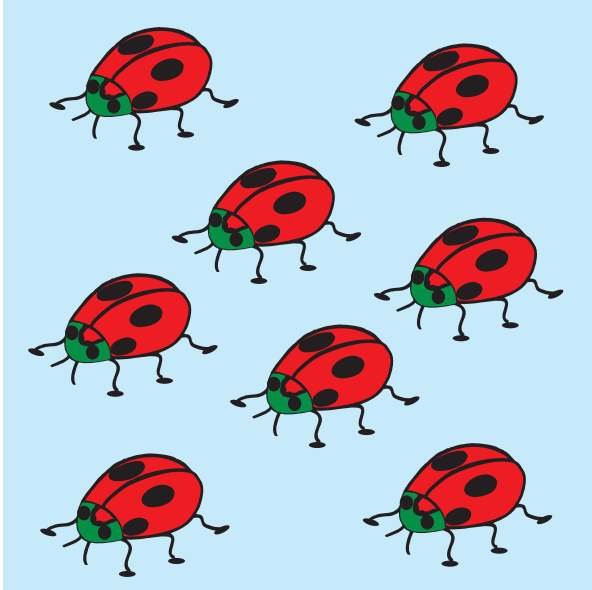

أُكْمِلُ



أُكْمِلُ



أُكْمِلُ



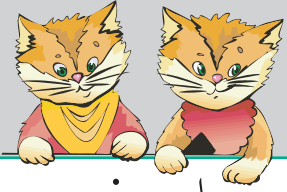

اسمي: ..... التاريخ: .....

أَلُوْن حَرْفَ لَ لَ وَأَضَعُ دَائِرَةً حَوْلَهُ فِي الْكَلِمَةِ



سُلْحَفَاةٌ

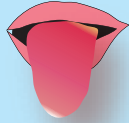

لِسَانٌ



لَبْوَةٌ

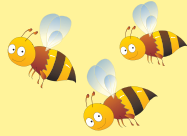

نَحْلٌ

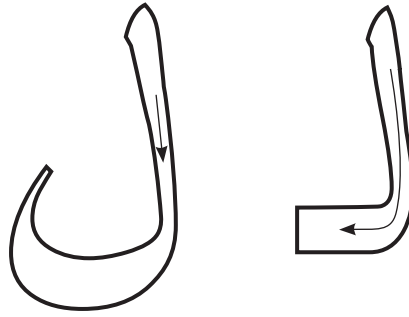

غَزَالٌ

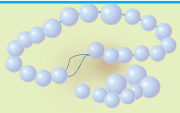

لُؤْلُؤٌ

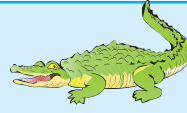

تِمْسَاحٌ

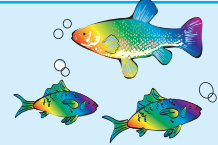

سَمَكٌ

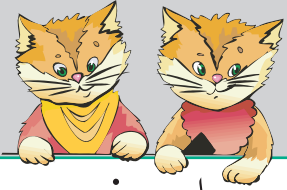

اسمي: ..... التاريخ: .....

## أَحْصِرْ وَأُحَدِّدُ الْعَدَدَ

أَحْصِرْ مِنْ كُلِّ مَجْمُوعَةٍ (٩) حَشْرَاتٍ:

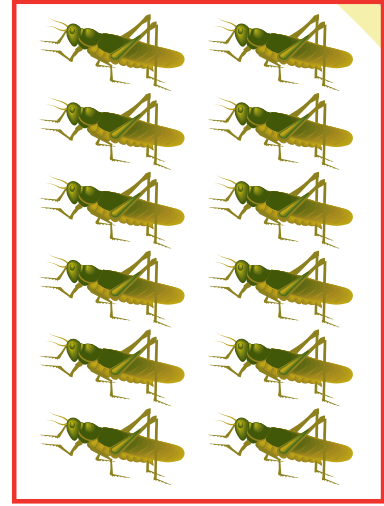
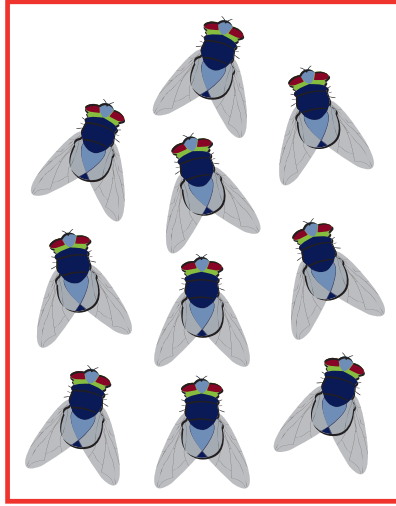
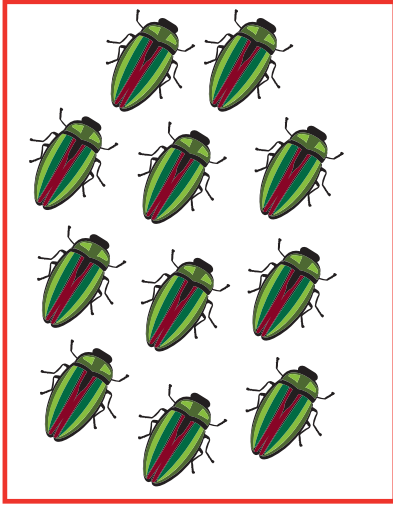

أَعِدُّ الْحَشْرَاتِ وَأَضِعْ دَائِرَةً حَوْلَ الْعَدَدِ فِي الْأَسْفَلِ:

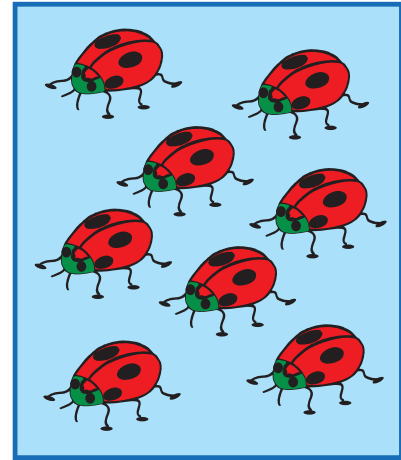
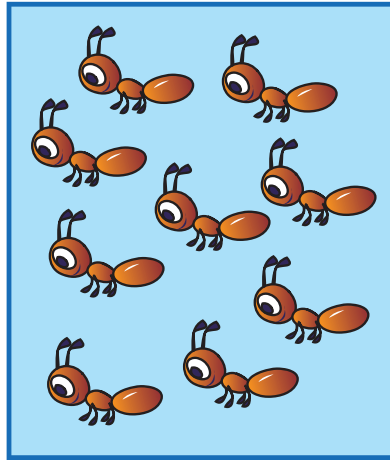
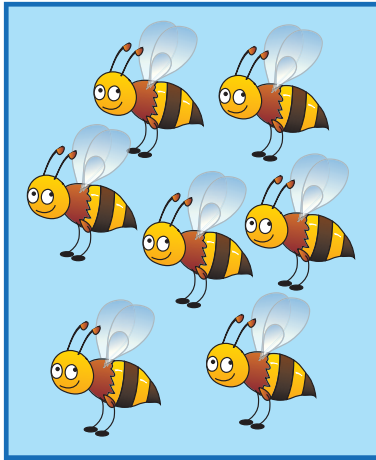

٩ ٨ ٧

٩ ٨ ٧

٩ ٨ ٧



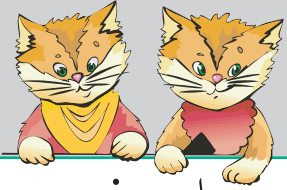

اسمي: ..... التاريخ: .....

## أَلَوْنٌ وَأَصْلٌ

أَبْحَثُ عَنْ (٩) وَأَلَوْنُهَا:



أَصِلُ الصَّوْرَةَ بِالْعَدَدِ:

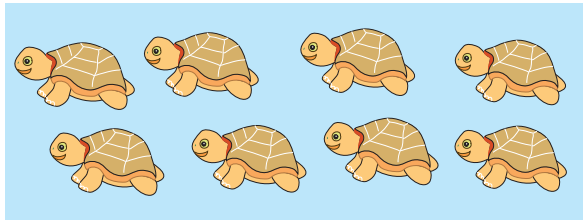
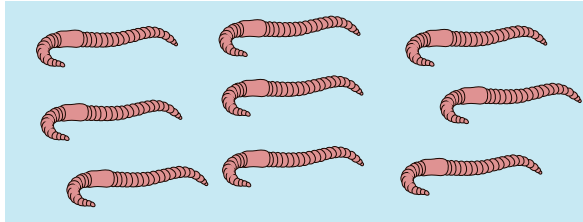
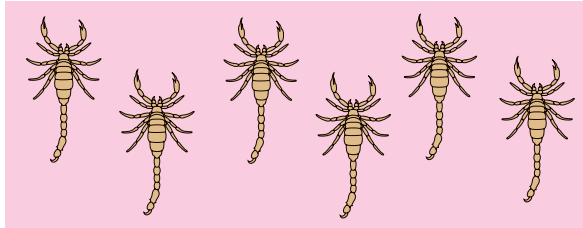
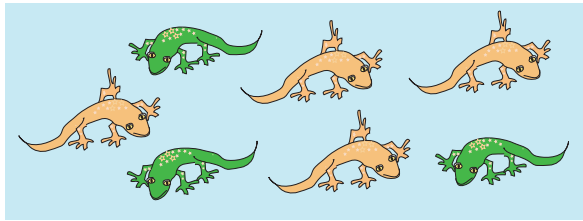

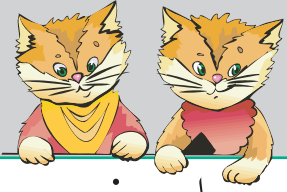

اسمي: ..... التاريخ: .....

## أرسم حرف ل ل

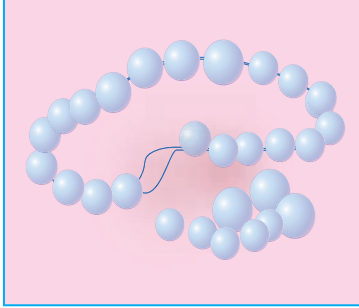

لؤلؤ

لؤلؤ

ؤلؤ

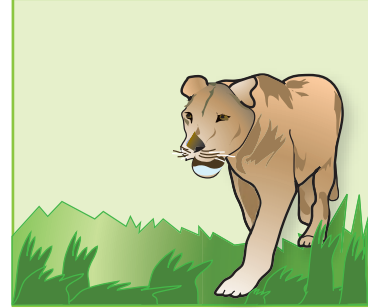

لبؤة

لبؤة

بؤة

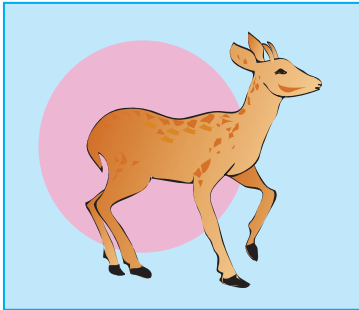

غزال

غزال

غزا

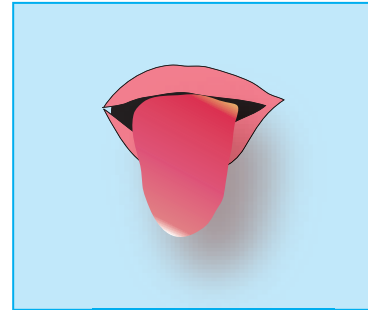

لسان

لسان

سان

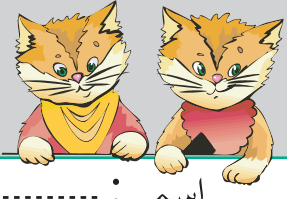

اسمي: ..... التاريخ: .....

## أصل الصورة بالكلمة

زُجاج

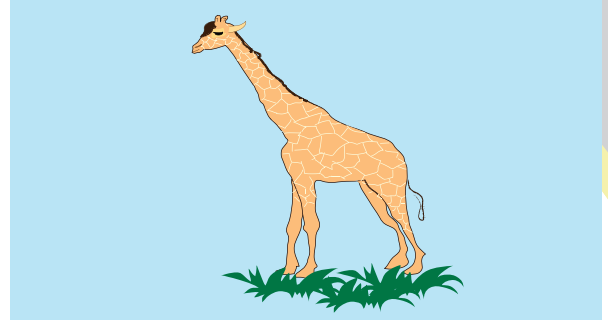

زرافة

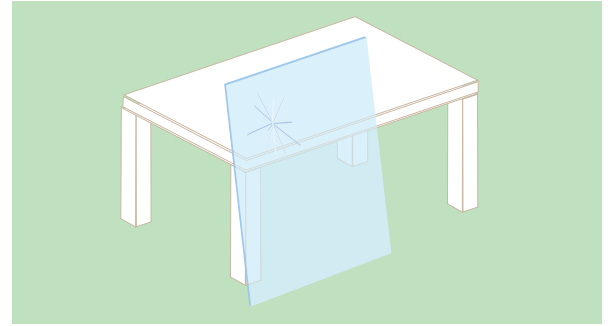

زر

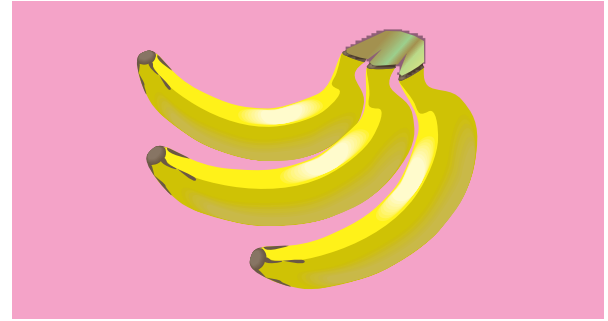

موز

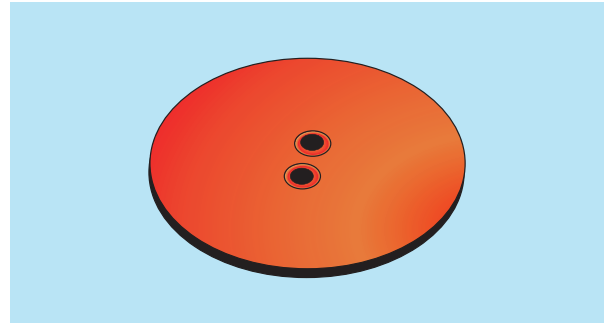

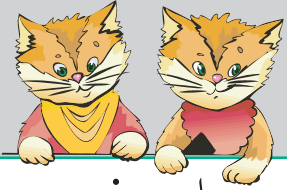

اسمي: ..... التاريخ: .....

## أَلَوْنُ وَأَكْتُبُ الْعِدَدَ ( ٩ )

أَلَوْنُ الْعِدَدِ (٩):

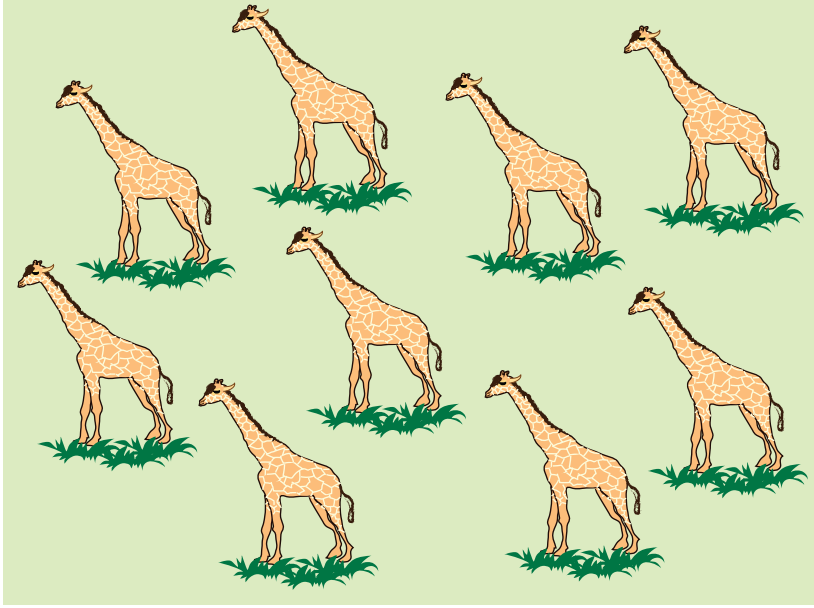

٩ ٩ ٩ ٩



أَكْمِلْ

٩ ٩ ٩ ٩



أَكْمِلْ

• • • •

أَكْمِلْ

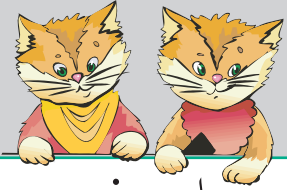

اسمي: ..... التاريخ: .....

أضع دائرة حول العدد المناسب في الأسفل:

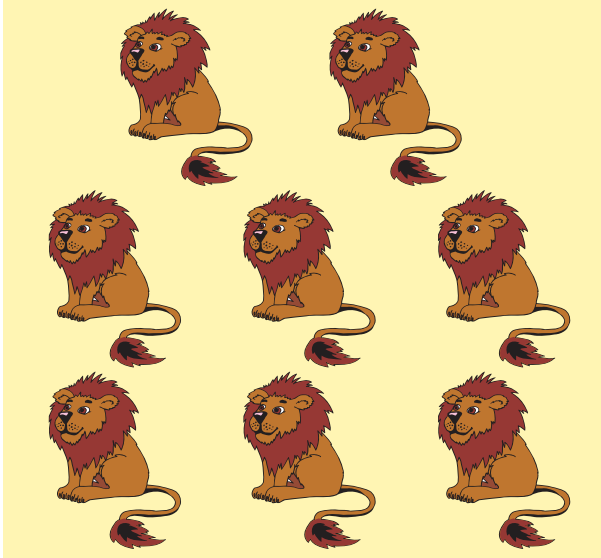

٩ ٨ ٧

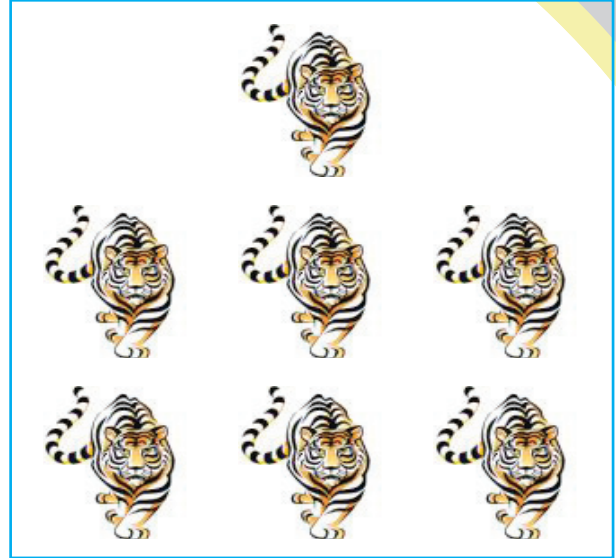

٩ ٨ ٧

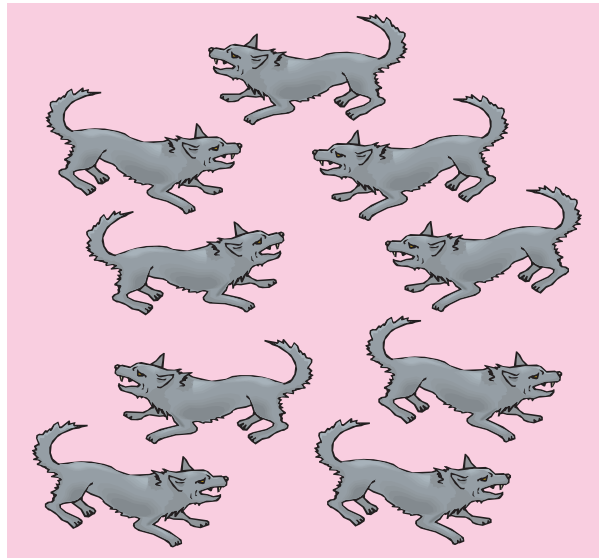

٩ ٨ ٧

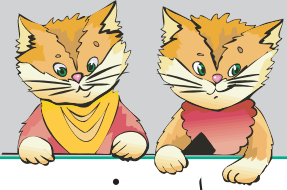

اسمي: ..... التاريخ: .....

## أَلَوْنُ حَرْفِ زُ وَأَضَعُ دَائِرَةً حَوْلَهُ فِي الْكَلِمَةِ

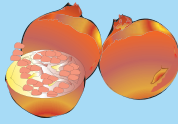

رُمان



زرافة



تمر



عصفور

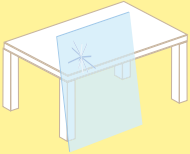

زجاج

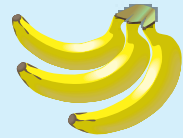

موز

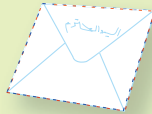

رسالة

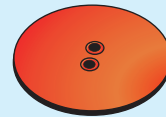

زر

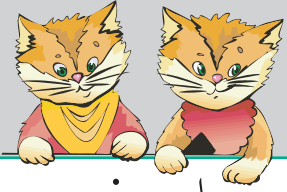

اسمي: ..... التاريخ: .....

## أرسمُ حرفَ ز

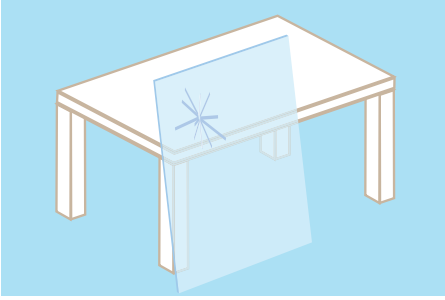

زُ جاج

زُ جاج

جاج .

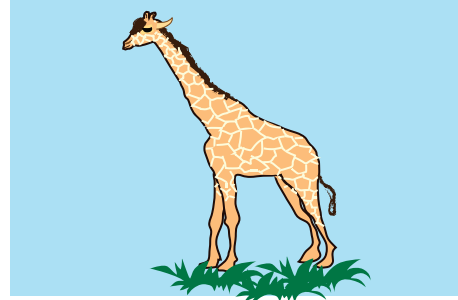

زَرافة

زَرافة

رافة .

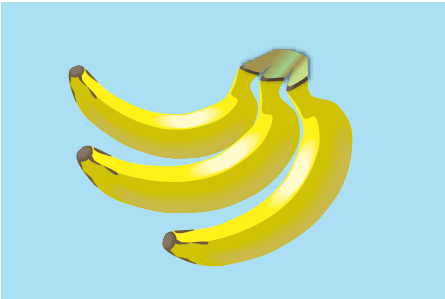

مَوز

مَوز

مَوز .

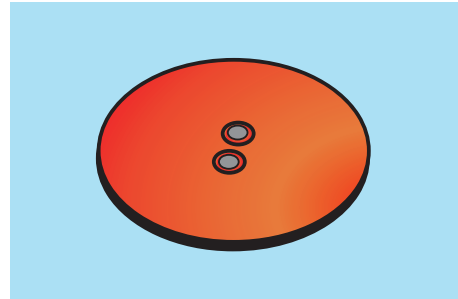

زِر

زِر

ر .

نلتقي في الفصل الثاني بإذن الله

# تم بحمد الله

